



D2 Series Printer User's Manual

D2-250 / D2-350



<http://www.argo.com>
service@argo.com

V1.1-11-12-2017

FCC ID

In a domestic environment this product may cause radio interference in which case the user may be required to take adequate measures.

FCC Warning

This equipment has been tested and found to comply with the limits for a Class A digital device, pursuant to Part 15 of the FCC Rules. These limits are designed to provide reasonable protection against harmful interference when the equipment is operated in a commercial environment. This equipment generates, uses, and can radiate radio frequency energy, and if not installed and used in accordance with the instructions in this manual, it may cause harmful interference to radio communications. Operation of this equipment in a residential area is likely to cause harmful interference in which case the user will be required to correct the interference at his own expense.

FCC Statement for Optional RF module

This device complies with RF radiation exposure limits set forth for an uncontrolled environment.

The antenna used for this transmitter must be installed to provide a separation distance of at least 20 cm from all people and must not be collocated or operating in conjunction with any other antenna or transmitter.

Bluetooth/Wireless LAN Communication

Compliance Statement

This product has been certified for compliance with the relevant radio interference regulations of your country or region. To make sure continued compliance, do not:

- Disassemble or modify this product.
- Remove the certificate label (serial number seal) affixed to this product.

Use of this product near microwave and/or other Wireless LAN equipment, or where static electricity or radio interference is present, may shorten the communication distance, or even disable communication.

WARNING

Changes or modifications not expressly approved by the party responsible for compliance could void the user's authority to operate the equipment.

(for USA only)

Liability Disclaimer

ARGOX Corporation takes steps to assure that the company's published engineering specifications and manuals are correct; however, errors do occur. ARGOX reserves the right to correct any such errors and disclaims any resulting liability. In no event shall ARGOX or anyone else involved in the creation, production, or delivery of the accompanying product (including hardware and software) be liable for any damages whatsoever (including, without limitation, damages for loss of business profits, business interruption, loss of business information, or other pecuniary loss) arising out of the use of or the results of use of or inability to use such product, even if ARGOX has been advised of the possibility of such damages.

Caution

Any changes or modifications not expressly approved by the party responsible for compliance could void the user's authority to operate the equipment.

Contents

1	Introduction	1
1.1	Features.....	1
1.2	Unpacking.....	2
1.3	Understand your printer	3
1.3.1	Perspective view	3
1.3.2	Back view	4
1.3.3	Interior view	5
1.4	Printer lights.....	6
1.4.1	Status lights.....	6
1.4.2	System mode.....	9
2	Get started	10
2.1	Attach the power cord	10
2.2	Turn on/off your printer	11
2.2.1	Turn on your printer.....	11
2.2.2	Turn off your printer	11
2.3	Load media.....	12
2.3.1	Prepare media.....	12
2.3.2	Place a media roll.....	13
2.3.3	Test media feed	16
2.4	Media types.....	17
2.5	Media sensing	19
2.5.1	Transmissive sensor	19
2.5.2	Reflective sensor	20
3	Printer operation.....	21
3.1	Printing Media Calibration & Configuration	21
3.2	Self test.....	22
	Option Parts	28
3.3	Reset your printer	33
3.4	Communications	34
3.4.1	Interfaces and Requirements.....	34
3.5	Driver installation.....	36
3.5.1	Installing a Plug and Play printer driver (for USB only).....	37
3.5.2	Installing a Printer Driver (for other interfaces except USB).....	42
4	Maintenance	48
4.1	Cleaning.....	48
4.1.1	Printhead.....	48

4.1.2	Media housing	49
4.1.3	Sensor.....	49
4.1.4	Platen roller.....	50
5	Troubleshooting	51
5.1	Printer issues.....	51
5.2	Media issues.....	52
5.3	Other issues.....	53
6	Specifications	54
6.1	Printer.....	54
6.2	Media	56
6.3	Electrical and operating environment.....	56
6.4	Physical dimension	56
6.5	Fonts, Barcodes, and Graphics Specification	57
6.6	Bluetooth(Optional).....	60
6.7	Ethernet(Optional).....	60
6.8	Wi-Fi(Optional).....	61
6.9	Ports	63
6.9.1	USB	63
6.9.2	Ethernet(Optional).....	64
6.9.3	RS-232C(Optional)	65

1 Introduction

Thank you for purchasing an Argox D2 Series industrial barcode printer. This manual provides information about how to set up and operate your printer, load media and solve common problems. Illustrations are provided to help you quickly become familiar with the printer.

1.1 Features

- **Clamshell design, easy loading:**

The D2 series features a user-friendly clamshell design that allows users to simply open the cover and loading media.

- **Compact size:**

Small footprint design, the compact D2 series fits into tight spaces and supports a wide range of applications.

- **Enhanced connectivity**

The D2 series has built-in USB host, USB device, and it can be expanded with Ethernet/RS232, Wi-Fi, and Bluetooth.

1.2 Unpacking

Make sure all of the following items are included in your package.

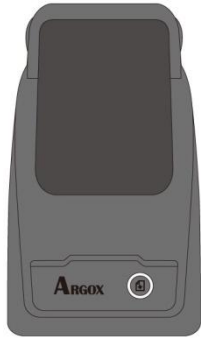

ARGOX D2 Printer

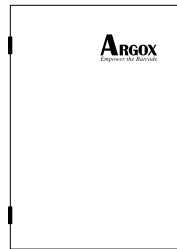

Quick Installation Guide

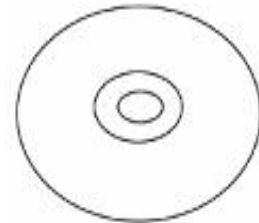

DVD

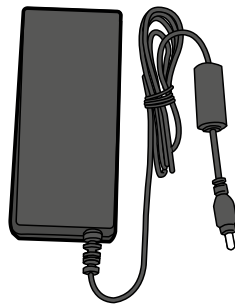

Power Supply

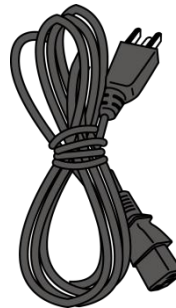

AC Power Cord

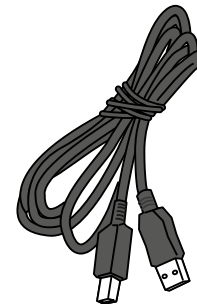

USB Cable

When you receive the printer, open the package immediately and inspect for shipping damage. If you discover any damage, contact the shipping company and file a claim. ARGOX is not responsible for any damage incurred during shipping. Save all package materials for the shipping company to inspect.



Note If any item is missing, please contact your local dealer.

1.3 Understand your printer

1.3.1 Perspective view

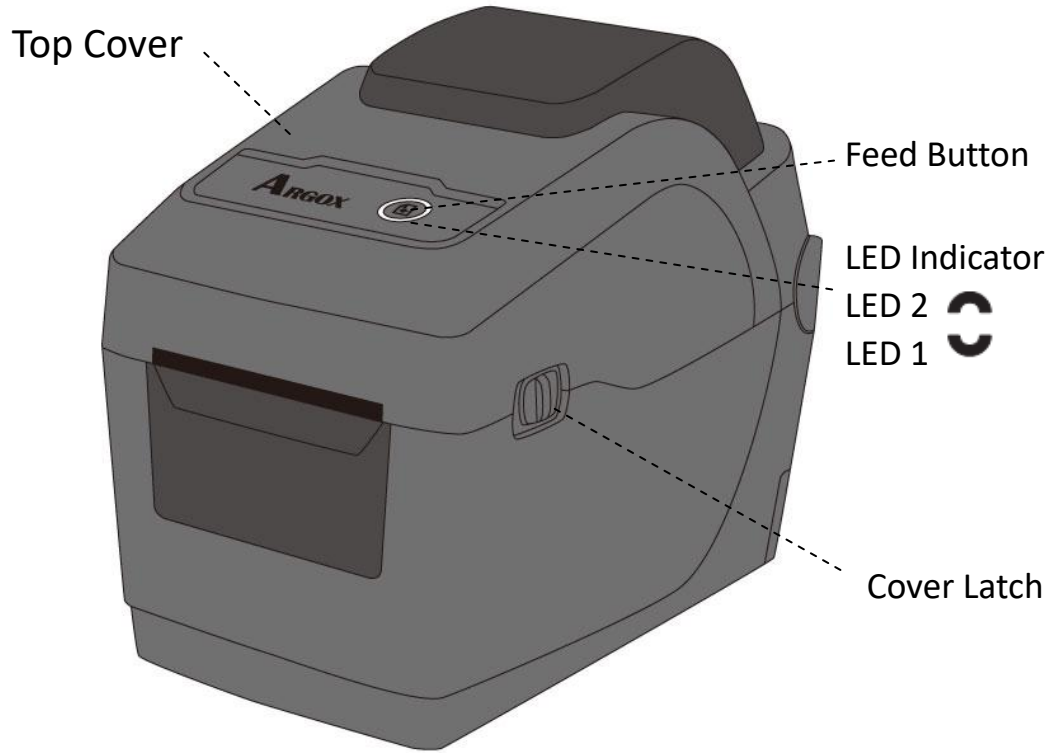

1.3.2 Back view

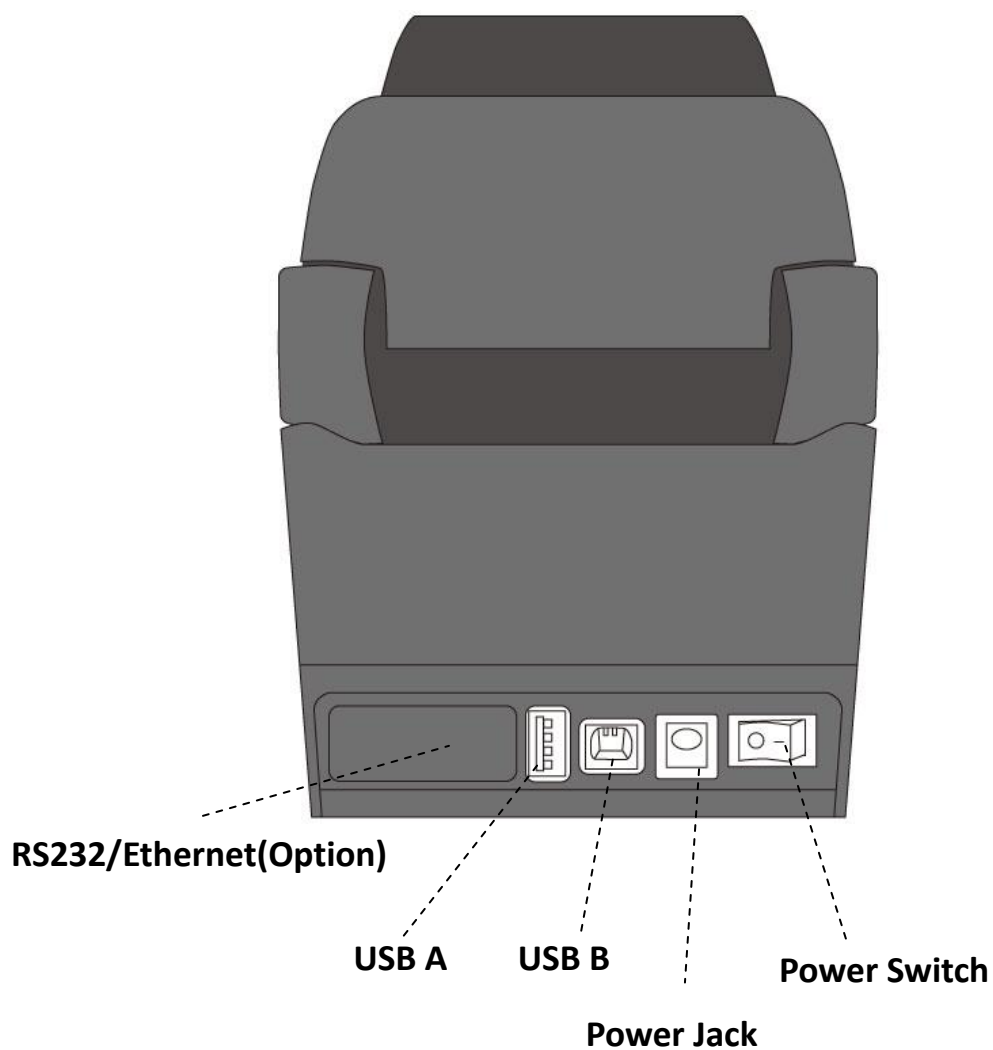

Caution To avoid injury, be careful not to trap your fingers in the Paper Slot while opening or closing the Top Cover.

1.3.3 Interior view

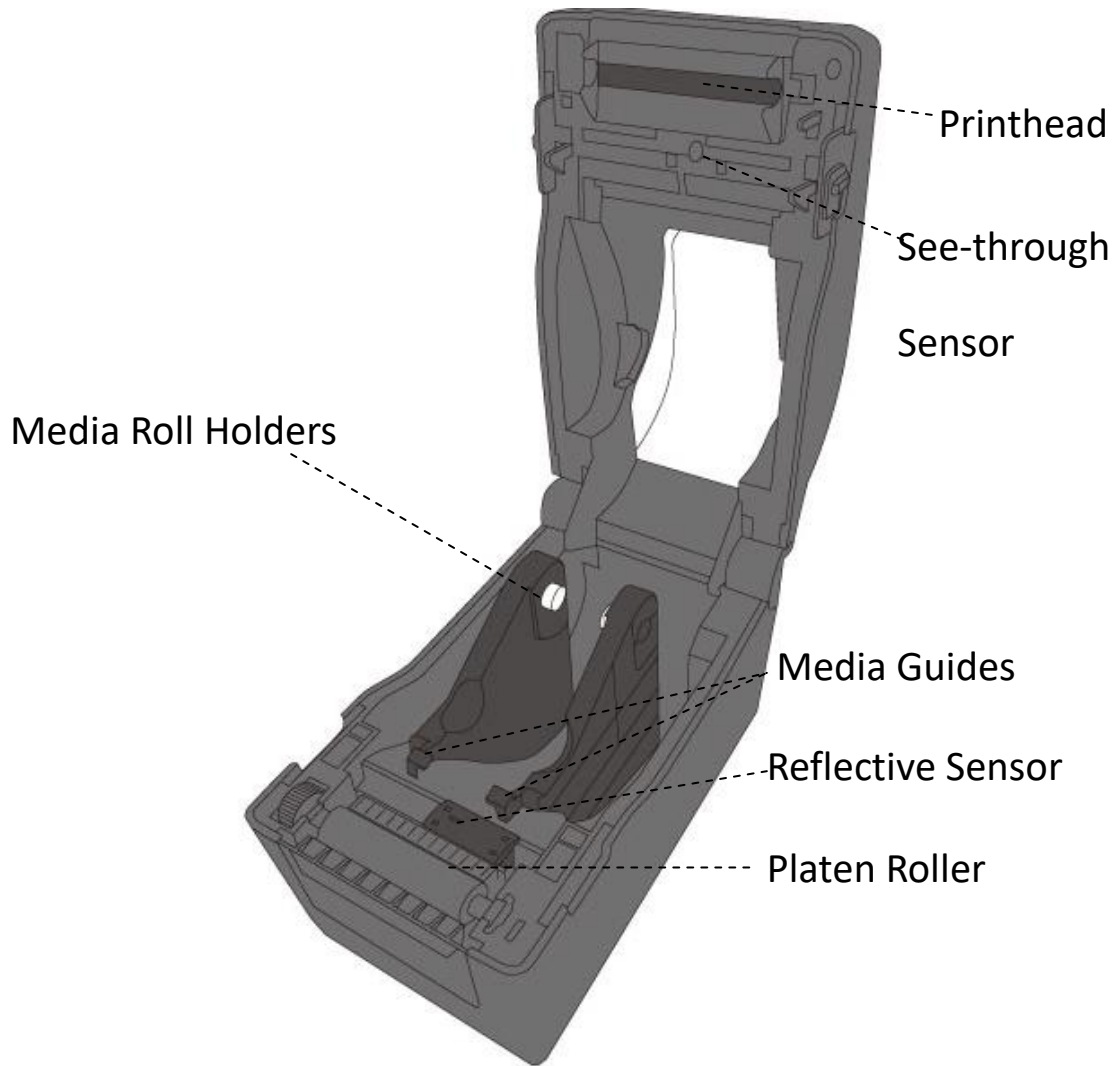

1.4 Printer lights

There are two LED lights that show the status of D2 Series printer. The Upside light is defined in LED2. LED1 is below LED2 and Feed symbol.





1.4.1 Status lights

Status lights help you check printer's condition. The following tables show the blinking speed of status lights and the conditions they indicate.

LED image	Blinking Speed	Blinking Interval
	Lightening	Always on
	Slow	0.8 Seconds
	Fast	0.2 Second

LED image	Blinking Pattern description
	Alternate blinking.
	Blinking at the same time.

Blinking pattern	LED 2	LED 1	Description
	Green	Green	The printer is ready to print.
	Green	Green	In pause.
	Green	Green	The printer is transmitting data.
	Green	Green	TPH high temperature.
	Green	Green	The printer is writing data to the flash or USB memory. The USB memory is being initialized.
	Amber	Amber	Paper jam. The media is out when the print data sent to the printer. Paper end.
	Red	Red	H/W Error
			The printhead is broken.
			Communication error (RS-232C).
			Cutter error (with optional cutter).
	Red	Red	The RTC battery is low. (If the printer has a built-in RTC)
			An EEPROM for backup cannot be read or written properly.
			A command has been fetched from an odd address.
			Word data has been accessed from a place other than the boundary of the word data.
			Long word data has been accessed from a place other than the boundary of the long word data.
Command error.			

	Red	Red	Top Cover Open	The print module is opened when the printer is turned on.
				Cover (Thermal Head) open error during printing.
	Red	Red	USB R/W Error	Flash ROM on the CPU board error or USB memory error.
				An erase error has occurred when formatting the USB memory.
				Unable to save files due to insufficient USB memory.

1.4.2 System mode

The system mode consists of status light color combinations. It contains a list of commands for you to select and run.

To enter the system mode and run the command, do the following:

1. Turn off the printer.
2. Press and hold the **FEED** button, and turn on the printer.
3. Both status lights glow solid Amber for a few seconds. Next, they turn to green shortly, and then turn to other colors.
4. When status lights show the color combination you need, release the **FEED** button immediately.
5. Press the **FEED** button to run the command.

The following table is the command list of the system mode.

LED 2	LED 1	Command
Red	Green	Transmissive Sensor Calibration (Section 3.1)
Amber	Green	Reflective Sensor Calibration (Section 3.1)
Red	Red	Resetting Your Printer (Section 3.3)
Amber	Red	Reserved
Green	Red	Disable Checking RTC Battery Charge
Red	Amber	Reserved
Green	Amber	Self-Test (Section 3.2)

2 Get started

This chapter describes how to set up your printer.



Caution Do not use your printer in areas exposed to splashing water or any other liquid.



Caution Do not drop your printer, or place it in an area subject to humidity, vibration or shock.

2.1 Attach the power cord

1. Make sure the power switch is set to the **OFF** position.
2. Insert the power supply's connector into the printer power jack.
3. Insert the AC power cord into the power supply.
4. Plug the other end of the AC power cord into the wall socket.

Important Use only power supplies listed in the user instructions.

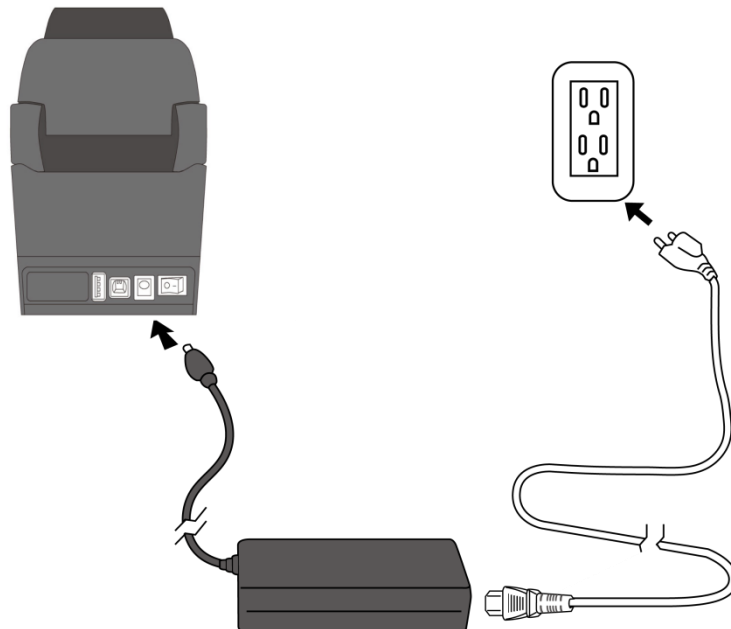

Warning Do not plug the AC power cord with wet hands, or operate the printer and the power supply in an area where they may get wet. Serious injury may result from these actions!

2.2 Turn on/off your printer

When your printer is connected to a host (a computer), it is good to turn on the printer before turning on the host, and turn off the host before turning off the printer.

2.2.1 Turn on your printer

1. To turn on your printer, turn on the **Power Switch** as below. The “I” is the **ON** position.

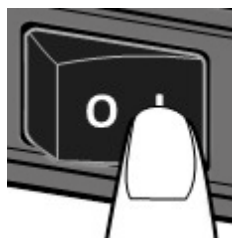

2. Both status lights glow solid Amber for a few seconds, then turns to solid green.



Note If you connect the printer to the internet or insert a USB drive before turning on the printer, it will take longer for the printer to enter the online mode after you turn it on.

2.2.2 Turn off your printer

1. Make sure LED is solid green before turning off the printer.
2. To turn off your printer, turn off the **Power Switch** as below. The “O” is the **OFF** position.

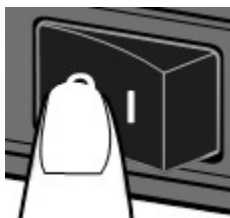

Caution Do not turn off your printer during data transmission.

2.3 Load media

There are various types and sizes for the media roll. Load the applicable media to satisfy your need.

2.3.1 Prepare media

The inside wound and outside wound media roll can be loaded into the printer the same way. In case the media roll is dirty during shipping, handling or storage, remove the outside length of the media. It helps avoid dragging adhesive and dirty media between the printhead and platen roller.

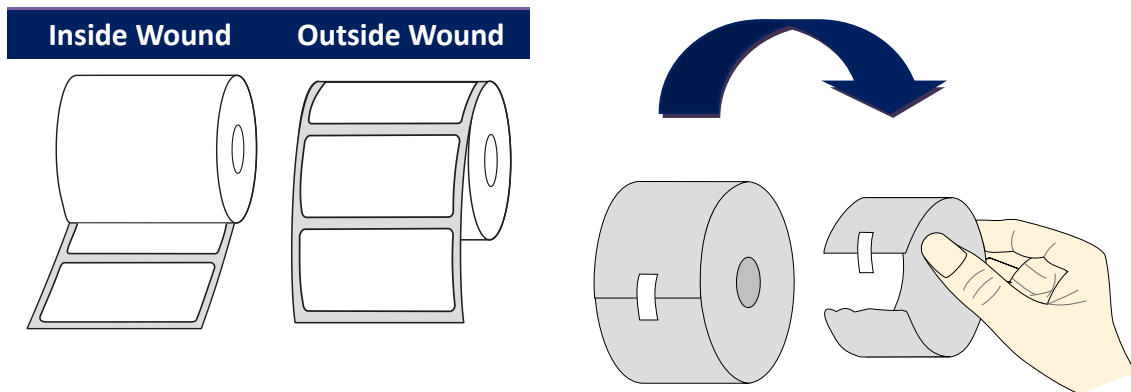

2.3.2 Place a media roll

1. Pull the head latch to open the top cover of the printer.



2. Pull the **Media Roll Holders** to slide them outward, and place the media roll between the holders. Make sure the print side is up, and the media roll is clamped tightly by the holders.

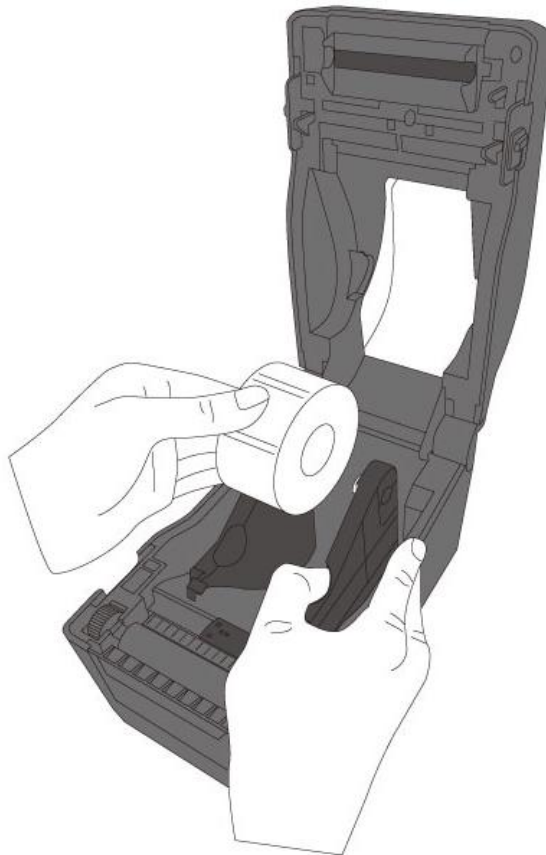

3. Pull the media until it reaches out of the printer. Thread the media under the media guides.

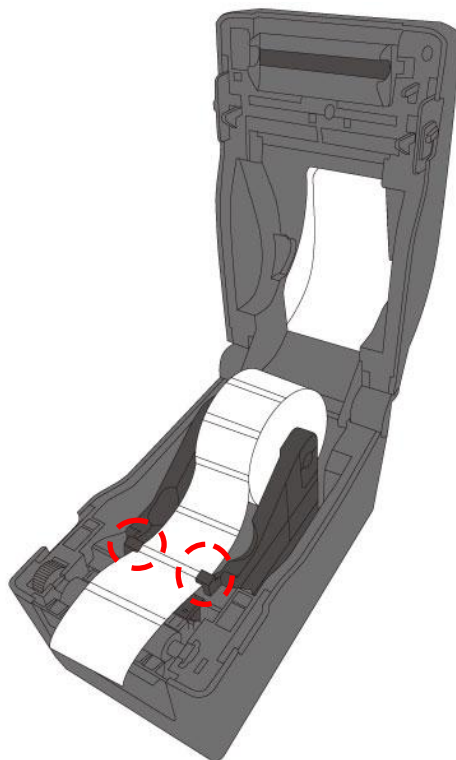

4. Close the top cover on both side.



More Humanity

If you usually use the same width media or fanfold media, scroll the “Media Roll Holder Wheel” to adjust width to the same media guide.

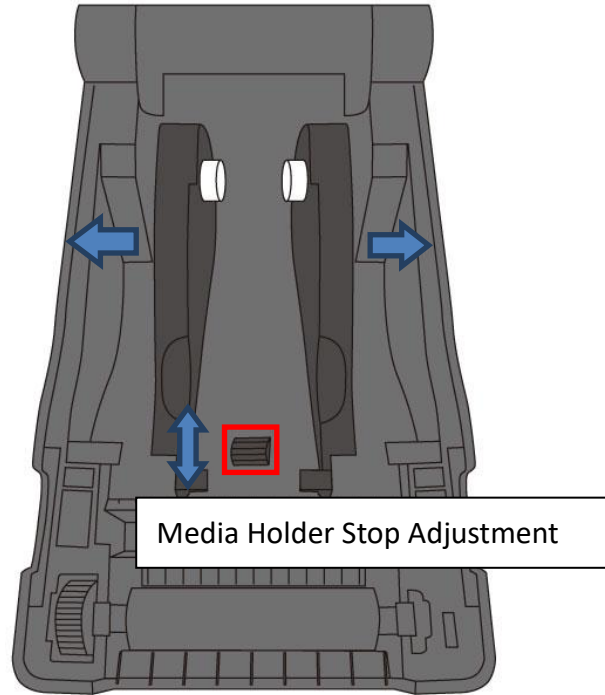

2.3.3 Test media feed

1. Turn on the printer, and press the **FEED** button to feed a label.

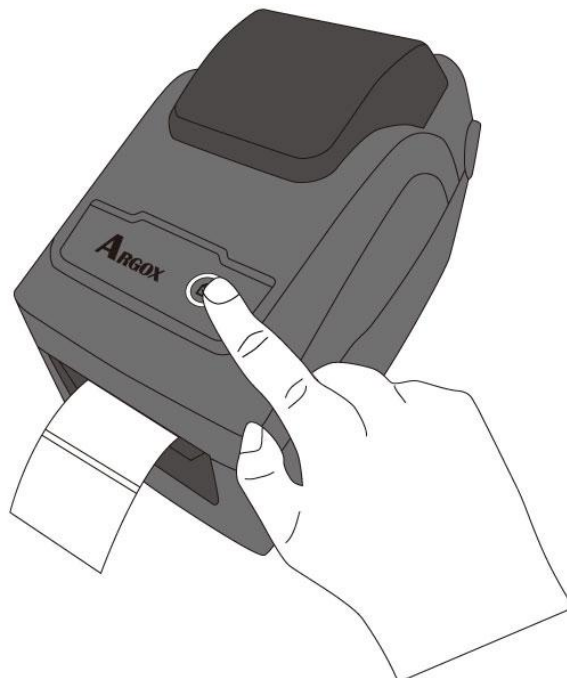



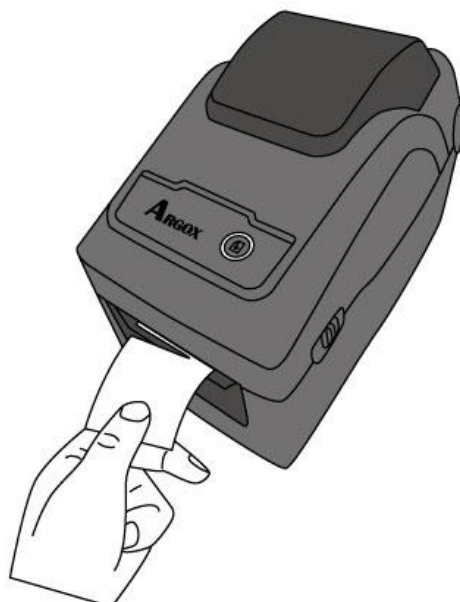

2. Flip the media and tear it along the edge of the front cover.

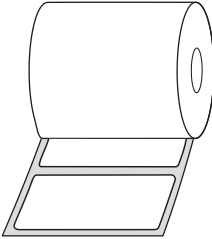
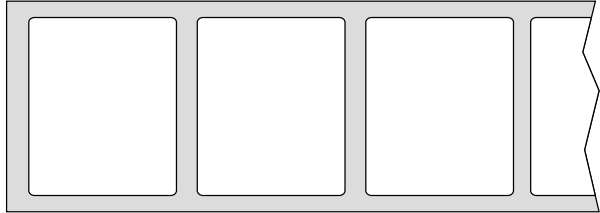
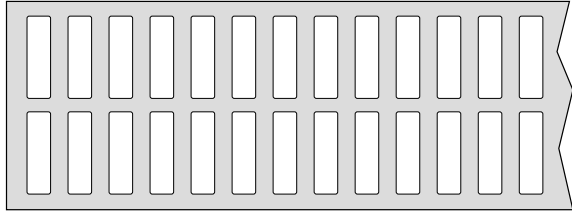
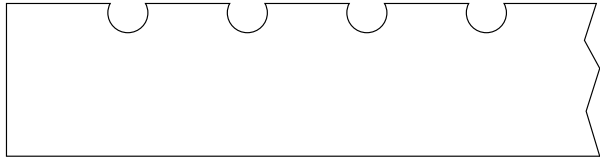

2.4 Media types

Your printer supports various media types, including non-continuous media, continuous media, and fanfold media. The following table provides details about them.

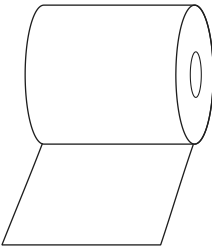
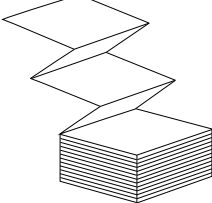
Media Type	Looks Like	Description
<p>Non-Continuous Media</p>	     	<p>Non-continuous media is the typical media for bar code printing. Labels and tags are made of various materials, such as paper, fabric or cardstock, and are separated by gaps, holes, notches or black marks. Many labels are self-adhesive with liners, while some are linerless.</p>

Media Type	Looks Like	Description
Continuous Media		<p>Continuous media does not have gaps, holes, notches or black marks. It allows you to print data anywhere on the media. A cutter may be used for splitting labels.</p>
Fanfold Media		<p>Fanfold media is in continuous form, but it can be used as non-continuous media, because its labels are separated by folds. Some fanfold media also has black marks or liners.</p>
Tag Media		<p>Tag media is usually made from a heavy paper, with central hole to index. It does not have adhesive or a liner, and it is typically perforated between tags. The media may also have black marks or other separations</p>

2.5 Media sensing

D4 printers offer two types of media sensor: transmissive and reflective. They are used for detecting specific media types.

2.5.1 Transmissive sensor

The transmissive sensor is fixed and placed near the center line with 6.27 mm offset of the printhead. It is used for detecting gaps across the entire width of the label.

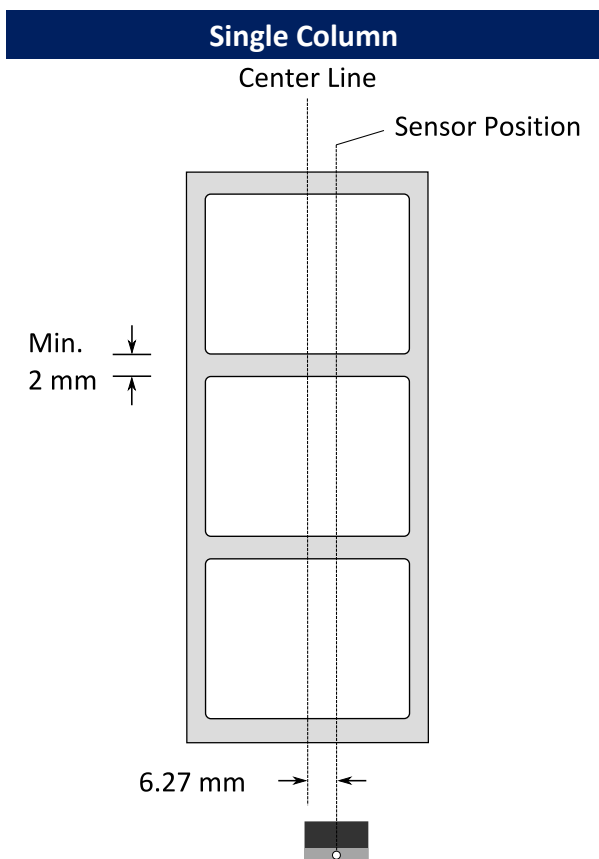

2.5.2 Reflective sensor

The reflective sensor is movable within the entire width of the media. It detects gaps, notches and black marks not located at the center of the media.

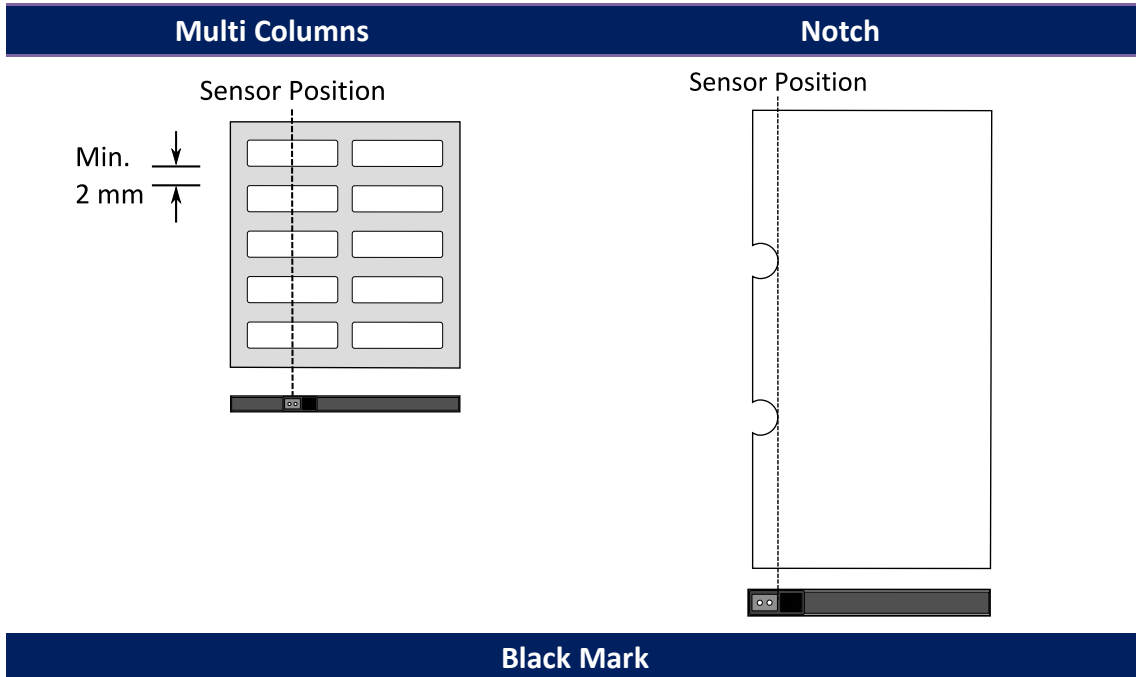

Flip the media so the black-mark side is facing down to align with the sensor.

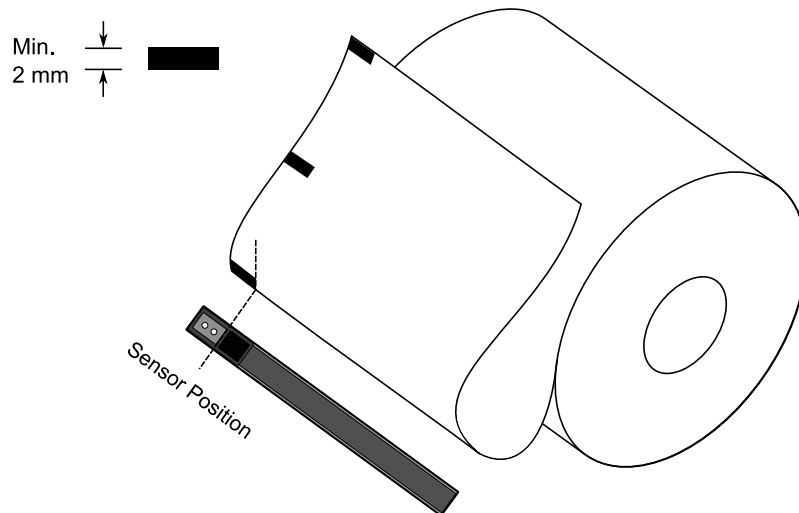

3 Printer operation

This chapter provides information about printer operation.

3.1 Printing Media Calibration & Configuration

You will want the printer to work properly before starting your print jobs. To do this, you need to calibrate the media sensor. Printers provide transmissive and reflective sensor calibration. Take the following steps to use them.

1. Make sure the media is properly loaded, the print module is closed, and the printer's power switch is set to the **OFF** position.
2. Press and hold the **FEED** button, and turn on the printer.
3. Both status lights glow solid Amber for a few seconds. Next, they turn to green shortly, and then turn to other colors. Do one of the following to select the sensor:
 - If you want to calibrate the transmissive sensor, when LED 2 turns to red and LED 1 turns to green, release the **FEED** button immediately.
 - If you want to calibrate the reflective sensor, when LED 2 turns to Amber and LED 1 turns to green, release the **FEED** button immediately.
4. Press the **FEED** button. The media calibration is complete after the printer feeds 3-4 labels and stops.

3.2 Self test

The printer can run a self test to print a configuration label, which helps you understand current settings of the printer.

1. Turn off the printer.
2. Press and hold the **FEED** button, and turn on the printer.
3. Both status lights glow solid Amber for a few seconds. Next, they turn to green shortly, and then turn to other colors. When LED 2 turns to green and LED 1 turns to Amber, release the **FEED** button.
4. Press the **FEED** button to print a configuration label.

Your configuration label should look like this:

PPLZ

```

1 LABEL PRINTER WITH FIRMWARE
2 D2-250-V01.00 20170807 PPLZ
3 STANDARD RAM : 32M BYTES
4 AVAILABLE RAM : 3684K BYTES
5 FLASH TYPE :
6 ON BOARD 16M BYTES
7 AVAILABLE FLASH :
8 8324K BYTES
9 NO.OF DL SOFT FONTS(FLASH):0
10 NO.OF DL SOFT FONTS(RAM) :0
11 NO.OF DL SOFT FONTS(HOST) :0
12 H. POSITION ADJUST.: 0008
13 SEE-THRU SENSOR
14 REF: 00C1 SEE: 004B
15 RTC TIME: 1/1/0(0:4:55)
16 MAX LABEL HEIGHT: 100 INCHES
17 PRINT WIDTH: 432 DOTS
18 LAB LEN(TOP TO TOP): 79mm
19 SPEED: 5 IPS
20 ABS. DARKNESS: 16
21 TRIM. DARKNESS: 0
22 DIRECT THERMAL
23 PRINT LENGTH: 0M
24 CUT COUNT:0
25 CARET CONTROL CHAR : <^>5EH
26 DELIMITER CONTROL CHAR : <, >2CH
27 TILDE CONTROL CHAR : <~>7EH
28 CODE PAGE : USA1
29 MEDIA : NON-CONTINUOUS
30 CALIBRATION MODE: INTELLI
31 REPRINT AFTER ERROR : ENABLED
32 BACKFEED ENABLED
33 CUTTER DISABLED
34 PEELER DISABLED
35 CUTTER/PEELER OFFSET:
36 0 <+~0.01mm>
37 PRODUCT SN: 00000000001
38 USB SN: 000000000001
39 CG ENABLED
40 EMU: AUTO
41 ot(0,0)<0.1dot,0.01mm>
42 rm(0,0)<1+ 0-,0.01mm>
43 sm(0,0)<1+ 0-,0.01mm>
44 rv(0,0,0)<0.01v><F>
45 sv(304,219,85)<0.01v><P>
46 rso(0)<0.01mm>
47 sso(0)<0.01mm>
48 ragc(134)<0.01v><P>
49 sagc(214)<0.01v><P>
50 sw: - - 0 0 0 -
51 1 2 3 4 5 6
52
53 FONT A. 0123ABCabc
54 FONT B. 0123ABCABC
55 FONT C. 0123ABCabc
56 FONT D. 0123ABCabc
57 FONT E. 0123ABCabc
58 FONT F. 0123ABCabc
59 FONT G.
60 FONT H. 0123ABC
61 Font CG 0123ABC

```

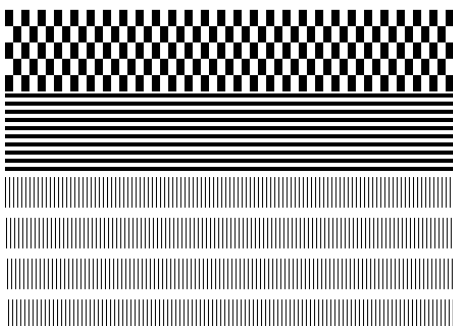

1. Version Information

The firmware version and its build date.

2. Standard RAM

Display SDRAM size.

3. Available RAM

RAM is able to be used.

4. Flash Type

The flash memory type and size.

5. Available Flash

Flash is able to be used.

6. No of DL soft fonts (FLASH)

The number of fonts is downloaded in Flash.

7. No of DL soft fonts (RAM)

The number of fonts is downloaded in RAM.

8. No of DL soft fonts (HOST)

The number of fonts is downloaded in USB HOST.

9. H. Position Adjust

Move the print position horizontally.

10. Sensor Type

Two kinds of media sensor type, reflective sensor and see-through sensor.

11. Label-less Calibration Value

Check if a label-less calibration has been performed on the printer. If not, the value is 0000.

12. RTC Time

The default format is month/day/year (hour:minute:second). If your printer has a built-in RTC, the RTC time shows here.

13. Max Label Height

The max label length you can print at a time. For 200 dpi models, it is 100 inches; for 300 dpi models, it is 50 inches.

14. Print Width

Display the print width in dots.

15. Lab Len (Top to Top)

For non-continues media, it is the length between the tops of two labels.

16. Speed

Printing speed unit is inch per second (ips).

17. ABS. Darkness

Display the current darkness. You can use the PPLZ command `~SD` to define it.

18. Trim. Darkness

Display the adjustment of the current darkness. You can use the PPLZ command `^MD` to define it.

19. Print Method

It is either thermal transfer (TT) or direct thermal (DT) printing. TT requires ribbons and DT doesn't.

20. Print Length

Display total print length.

21. Cut Count

It counts the times the cutter cuts.

22. Caret Control Char

The control character your printer is using.

23. Delimiter Control Char

The control character your printer is using.

24. Tilde Control Char

The control character your printer is using.

25. Code page

The character set table.

26. Media

The media type in use.

27. Calibration mode

There are Intelli Mode and Smart Mode.

Intelli Mode: Just install labels, latch print module, press FEED button once, and then the printer will feed 1-2 labels to detect next gap / black mark before printing. The printer will feed 1-2 labels automatically before printing, if FEED button is not pressed.

Smart Mode: Print from the first label immediately according to label length setting. Make sure to carefully align label bottom edge at the tear-off position before printing.

28. Reprint After Error

When it is enabled, your printer reprints the label after the error fixed if it is printed incorrectly due to the error.

29. Backfeed Enabled/Disabled

Enable or disable backfeed during the printing process. When it is enabled, the printer moves the paper forward in a predefined length 1 second after printing, and pulls the paper back in a predefined length once the printing begins again. When it is disabled, the printer won't move the paper at all.

30. Cutter Enabled/Disabled

Enable or disable the cutter during the printing process.

31. Peeler Enabled/Disabled

Enable or disable the dispenser during the printing process.

32. Cutter/Peeler Offset

Move the cutting line or the peeling position forward or backward. The value in the angle brackets is the offset unit.

33. Product SN

Display printer serial number.

34. USB SN

Display printer USB host serial number.

35. CG Enable

Printer is able to use True Type font.

36. EMU Auto

Printer is in the Auto Emulation mode

37. TPH and Cutter Offset

This is for developers to debug.

38. Reflective Sensor Gap Calibration

This is for developers to debug.

39. See-Through Sensor Gap Calibration

This is for developers to debug.

40. Reflective Sensor Profile

This is for developers to debug.

41. See-Through Sensor Profile

This is for developers to debug.

42. Ribbon Voltage Delta

This is for developers to debug.

43. Reflective Sensor Offset

This is for developers to debug.

44. See-Through Sensor Offset

This is for developers to debug.

45. See-Through Sensor Automatic Gain Control

This is for developers to debug.

46. SW

Display status of the dip switch.

47-55. Font Image

You can use them as the reference to check your label font.

56-61. TPH Test Pattern

You can use them to check broken pins on the printhead.

Option Parts

If your printer has a RS-232 module, your PPLZ configuration label will contain the following entries:

RS232 Protocol

It lists RS-232C settings in the following order: baud rate, data length, parity check, stop bit and flow control.

If your printer has an Ethernet module, your PPLZ configuration label will contain the following entries:

IP Address

Display printer current IP address in. The default value is "192.168.1.1".

Subnet Mask

Display printer subnet mask. The default value is "255.255.255.0."

Gateway

Display printer gateway. The default value is "0.0.0.0."

MAC Address

The unique address assigned to the printer that connects to the internet.

DHCP

When DHCP is enabled, it assigns a dynamic IP address to the printer automatically.

DHCP Client ID

It is an arbitrary value sent to the DHCP server to reserve an IP address for the printer.

DHCP Host Name

It is the name of a DHCP client. The host name allows up to 32 alphanumeric characters.

SNMP

When it is enabled, the host gets or sets parameters registered as SNMP entities.

Socket Communication

When it is enabled, the host communicates with the printer via the socket.

Socket Port

Display printer port number.

IPv6 Mode

It determines how you get the IPv6 address of your printer. There are three modes: MANUAL, DHCPv6 or AUTO.

IPv6 Type

It is the IPv6 address type of your printer. There are four types: NONE, NORMAL, EUI and ANY.

IPv6 Address

Display printer current IPv6 address.

Link Local

The IPv6 address that used in a network segment. It is allocated automatically.

If your printer has a Wi-Fi module, your PPLZ configuration label will contain the following entries:

FW Version

Display WLAN board firmware version.

Date

Display WLAN board firmware version date.

IP Address

Display the IP address of your printer. When DHCP is enabled, it shows the automatically assigned IP address; when DHCP is disabled, it shows the manually specified IP address.

Subnet mask

Display the current IPv4 subnet mask of your printer in Wi-Fi module.

Gateway

Display the gateway of your printer. When DHCP is enabled, it shows the automatically assigned gateway; when DHCP is disabled, it shows the manually specified gateway.

Mac address

The unique address assigned to your printer that connects to the internet.

DHCP

When DHCP is enabled, it assigns an IP address to your printer automatically.

DHCP Hostname

Display the name of a DHCP client in Wi-Fi module.

Socket Port

Display the socket number of the printer in Wi-Fi module.

SSID

Short for service set identifier. It is the name of a wireless local area network.

Mode

There are ad-hoc and infrastructure mode. Refer to Print Tool Network type description from Technical manual.

Country Code

Display the country or region in Wi-Fi module.

Channel

Display the Wi-Fi channel.

Network Authentication

There are six modes. Refer to Printer Tool Network authentication description from Technical manual.

WEP

Display the printer WEP encryption is on or off.

PPLA

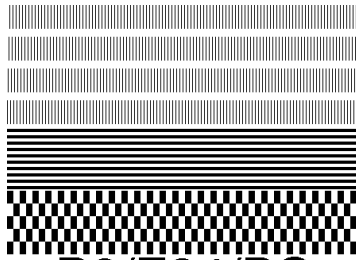

R8/E94/PC

Courier Font

Smooth font(18)

Smooth font(14)

Smooth font(12 points)

Smooth font(1 points) - 12345

Smooth font(8 points) - 123456789 AB

Smooth font(6 points) - 123456789 ABCabcXyz

123456789

font7. 0CR-A ABCabc

FONT

FONT5. 012345678

FONT4. 012345678

FONT3. 0123456789 ABCABC

font2. 0123456789 ABCabcXyz

font1. 0123456789 ABCabcXyz

font0. 0123456789 ABCabcXyz

1 2 3 4 5 6

sw: - - 0 0 0 -

sa9c(214)<0.01u><P>

ra9c(134)<0.01u><P>

sso(0)<0.01mm>

rso(0)<0.01mm>

su(304,219.85)<0.01u><P>

rv(0.0,0)<0.01u><F>

sm(0.0)<1+ 0- 0.01mm>

rm(0.0)<1+ 0- 0.01mm>

ot(0.0)<0.1dot,0.01mm>

CG ENABLED

USB SN: 000000000001

PRODUCT SN: 000000000001

0 <+-0.01mm>

CUTTER/PEELER OFFSET:

PEELER DISABLED

CUTTER DISABLED

BACKFEED ENABLED

CALIBRATION MODE: INTELLI

MEDIA : NON-CONTINUOUS

STD CTRL CODES

CODE PAGE : PC-850

CUT COUNT:0

PRINT LENGTH: 0M

DIRECT THERMAL

DARKNESS: 10

SPEED: 5 IPS

LAB LEN(TOP TO TOP): 79mm

PRINT WIDTH: 801 DOTS

MAX LABEL HEIGHT: 100 INCHES

RTC TIME: 1/1/0(2:0:37)

REF: 00C1 SEE: 004B

SEE-THRU SENSOR

H. POSITION ADJUST.: 0008

NO. OF DL SOFT FONTS(HOST) :0

NO. OF DL SOFT FONTS(RAM) :0

NO. OF DL SOFT FONTS(FLASH):0

8324K BYTES

AVAILABLE FLASH :

ON BOARD 16M BYTES

FLASH TYPE :

AVAILABLE RAM : 3684K BYTES

STANDARD RAM : 32M BYTES

D2-250-V01.00 20170807 PPLA

LABEL PRINTER WITH FIRMWARE

PPLB

LABEL PRINTER WITH FIRMWARE
 D2-250-V01.00 20170807 PPLB
 STANDARD RAM : 32M BYTES
 AVAILABLE RAM : 3684K BYTES
 FLASH TYPE :
 ON BOARD 16M BYTES
 AVAILABLE FLASH :
 8324K BYTES
 NO.OF DL SOFT FONTS(FLASH):4
 NO.OF DL SOFT FONTS(RAM) :0
 NO.OF DL SOFT FONTS(HOST) :0
 H. POSITION ADJUST.: 0008
 SEE-THRU SENSOR
 REF: 00C1 SEE: 004B
 RTC TIME: 1/1/0(0:9:18)
 MAX LABEL HEIGHT: 100 INCHES
 PRINT WIDTH: 432 DOTS
 LAB LEN(TOP TO TOP): 79mm
 SPEED: 5 IPS
 DARKNESS: 8
 DIRECT THERMAL
 PRINT LENGTH: 0M
 CUT COUNT:0
 CODE PAGE : English (437)
 MEDIA : NON-CONTINUOUS
 CALIBRATION MODE:INTELLI
 BACKFEED ENABLED
 CUTTER DISABLED
 PEELER DISABLED
 CUTTER/PEELER OFFSET:
 0 <+-0.01mm>
 PRODUCT SN: 00000000001
 USB SN: 000000000001
 CG ENABLED
 ot(0,0)<0.1dot,0.01mm>
 rm(0,0)<1+ 0-,0.01mm>
 sm(0,0)<1+ 0-,0.01mm>
 rv(0,0,0)<0.01v><F>
 sv(304,219,85)<0.01v><P>
 rso(0)<0.01mm>
 sso(0)<0.01mm>
 ragc(134)<0.01v><P>
 sagc(214)<0.01v><P>
 sw: - - 0 0 0 -
 1 2 3 4 5 6
 font 1. 0123456789 ABCabcXyz
 font 2. 0123456789 ABCabcXyz
 font 3. 0123456789 ABCabcXy
 font 4. 0123456789 ABCXY

FONT 5

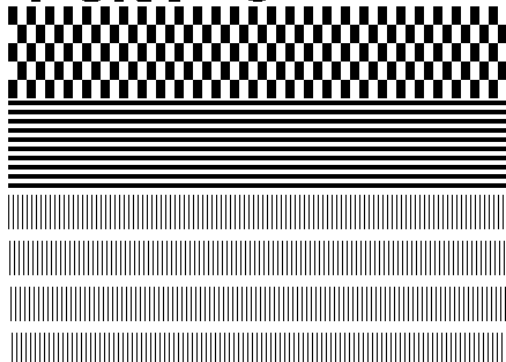

3.3 Reset your printer

By resetting your printer, you can return your printer to the state it was in when you receive it. This can help you solve some problems caused by settings changed during the printing.

Do the following to reset your printer:

1. Turn off the printer.
2. Press and hold the **FEED** button, and turn on the printer.
3. Both status lights glow solid Amber for a few seconds. Next, they turn to green shortly, and then turn to other colors. When both lights turn to red, release the **FEED** button immediately.
4. Press and hold the **FEED** button over 3 seconds and release it. Both status lights blink red three times, and turn to solid Amber for a few seconds. After the printer is reset, LED 1 goes out while LED 2 turns to solid green.



Important In step 4, if you do not hold the **FEED** button long enough, LED 1 will blink Amber three times while LED 2 goes out. It means the printer is not reset.

3.4 Communications

3.4.1 Interfaces and Requirements

This printer comes with USB type A and type B interface, a nine-pin Electronics Industries Association (EIA) RS-232 serial data interface.

■ USB Interface Requirements

The Universal Serial Bus (USB) interface is compatible with your existing PC hardware. The USB's "plug and play" design makes installation easy. Multiple printers can share a single USB port/hub. The different usage of type A and B are as below.

USB type A	USB Flash drive, USB keyboard or USB Scanner.
USB type B	PC to set printer.

■ Serial (RS-232) Port(Optional)

The required cable must have a nine-pin "D" type male connector on one end, which is plugged into serial port located on the back of the printer. The other end of the cable connects to a serial port on the host computer. For technical and pin-out information, please refer to [RS-232C](#) in this manual.

■ Ethernet Module Status Indicators(Optional)

The indicators with two different colors help users understand status of Ethernet:

LED Status	Description
Both Off	No Ethernet link detected.
Blinking	The printer waits for printer ready. It will take about few seconds to be ready.

Green	Speed LED	On: 100 Mbps link Off: 10 Mbps link
Amber	Link/Activity LED	On: link up Off: link down Blinking: activity

3.5 Driver installation

The bundled printer driver can be applied to all applications under Windows Vista/ Windows 7/ Windows 8/ Windows 10, supporting 32-bit/ 64-bit operation systems. With this driver you can operate any popular Windows software applications including Argox Bartender UL label editing software or MS Word, etc., to print to this printer.

We strongly recommend that you use the Seagull Driver Wizard instead of the Microsoft Windows Add Printer Wizard when installing and updating your Drivers by Seagull.

(Even though the "Add Printer Wizard" is from Microsoft, it too easily performs a number of tasks incorrectly when updating existing drivers. It also badly handles the situation where a printer driver is already in use by a Windows application.)

Drivers can be downloaded from Argox website

3.5.1 Installing a Plug and Play printer driver (for USB only)

1. Turn off the printer. Plug the power cable into the power socket on the wall, and then connect the other end of the cable to printer's power socket. Connect the USB cable to the USB port on the printer and on the PC.
2. Run the driver from Argox website. On the prompt, Windows Printer Driver, select "I accept..." and click "Next".



3. Assign the directory to keep Seagull driver, (for example: C:\Seagull) and click "Next".

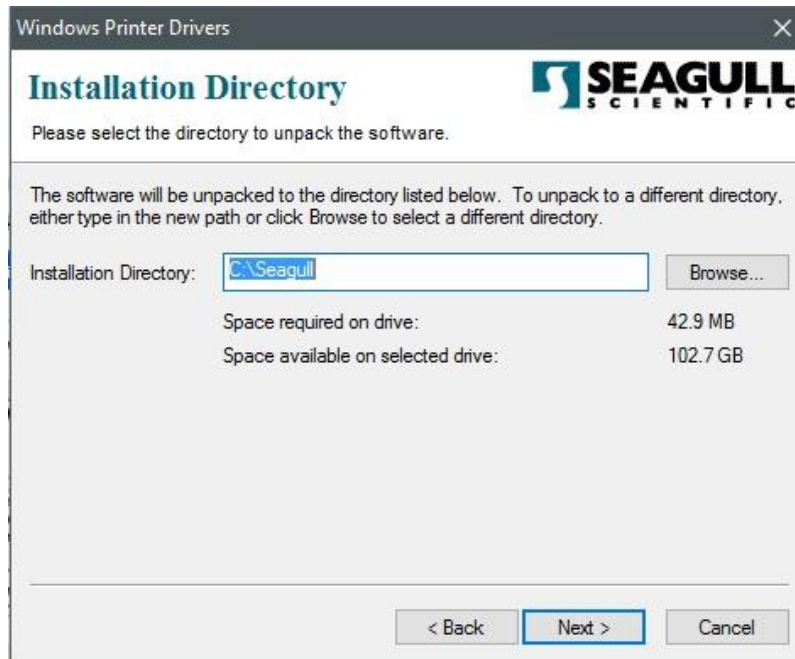

4. Click "Finish".



5. Select Install printer drivers and Click "Next"

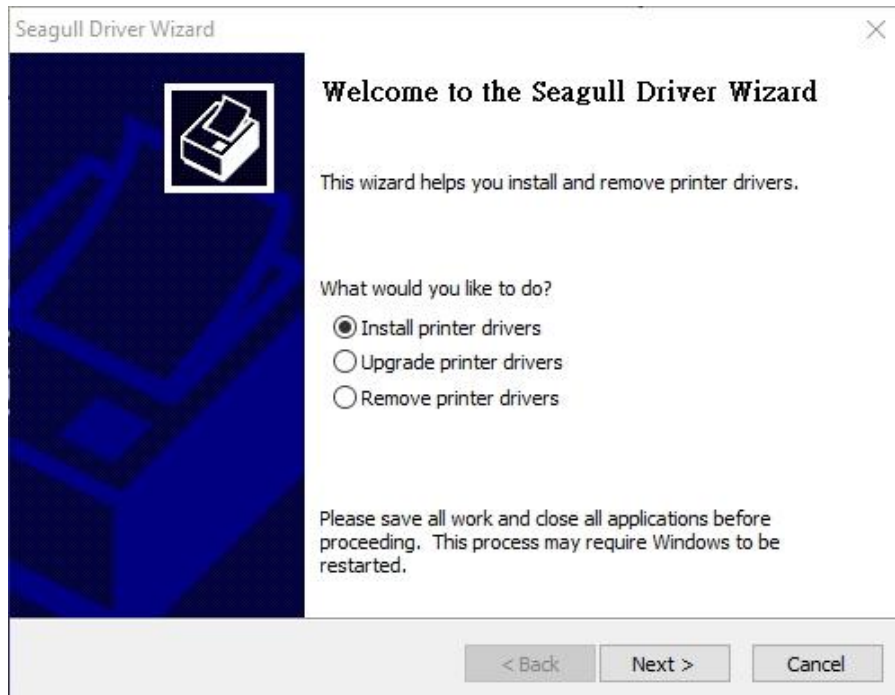

6. On the Seagull Driver Wizard prompt, select the first radio button to "Install a driver for a Plug and Play printer" Then click "Next."

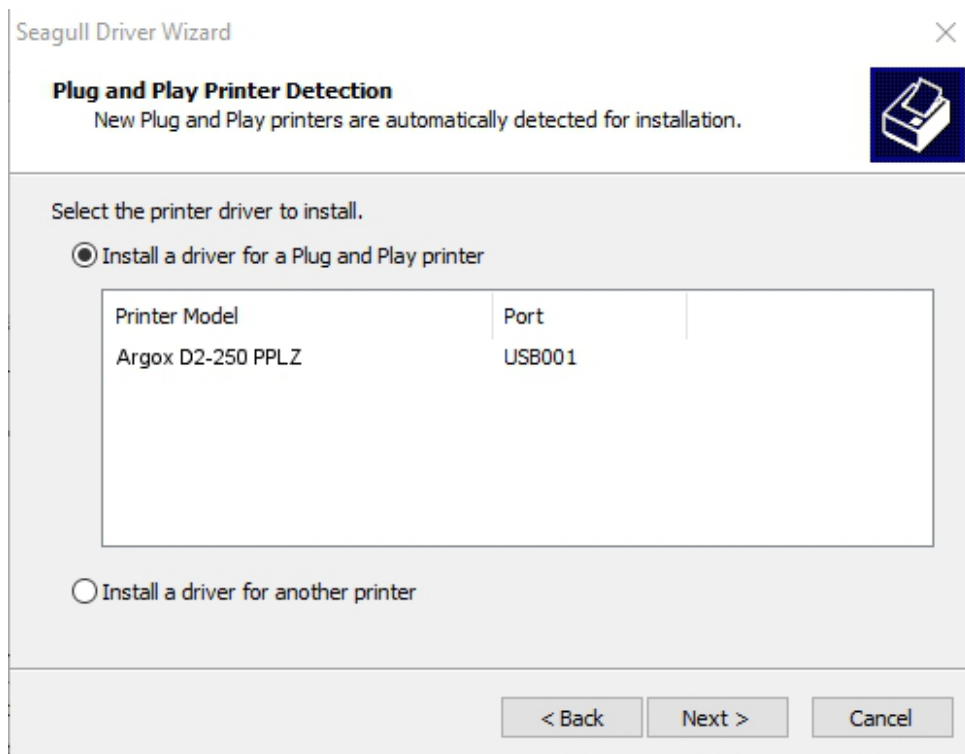

7. Enter Printer name (i.e. Argox D2-250 PPLZ) and select "do not share this printer", and click "Next"

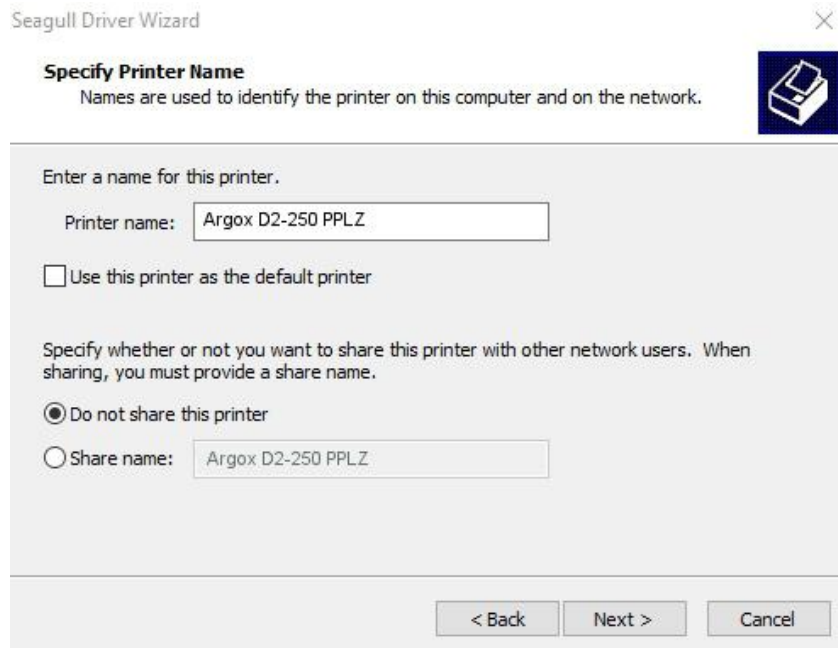

Seagull Driver Wizard

Specify Printer Name
Names are used to identify the printer on this computer and on the network.

Enter a name for this printer.

Printer name:

Use this printer as the default printer

Specify whether or not you want to share this printer with other network users. When sharing, you must provide a share name.

Do not share this printer

Share name:

< Back Next > Cancel

8. Check all the data on the showing screen, if it is correct, click "Finish".



Seagull Driver Wizard

Completing the Seagull Driver Wizard

A new printer will be installed using the following settings:

Name:	Argox D2-250 PPLZ
Share name:	<Not Shared>
Port:	USB001
Default:	Yes
Manufacturer:	Argox
Model:	Argox D2-250 PPLZ

To begin the driver installation process, click Finish.

< Back Finish Cancel

9. After the related files have been copied to your system, click "Finish".

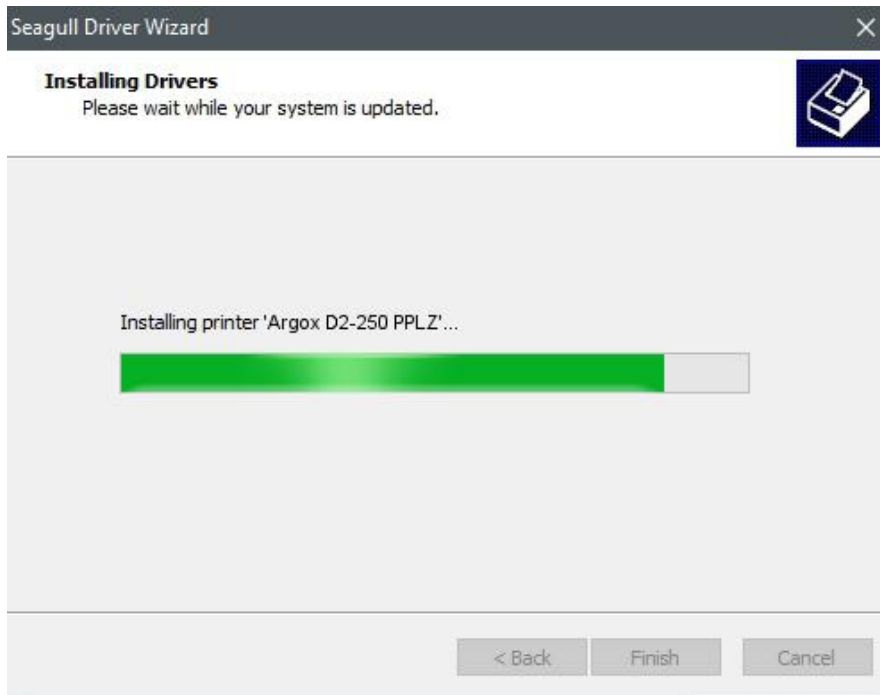

10. After driver installation is complete, click "Close". The driver should now be installed.

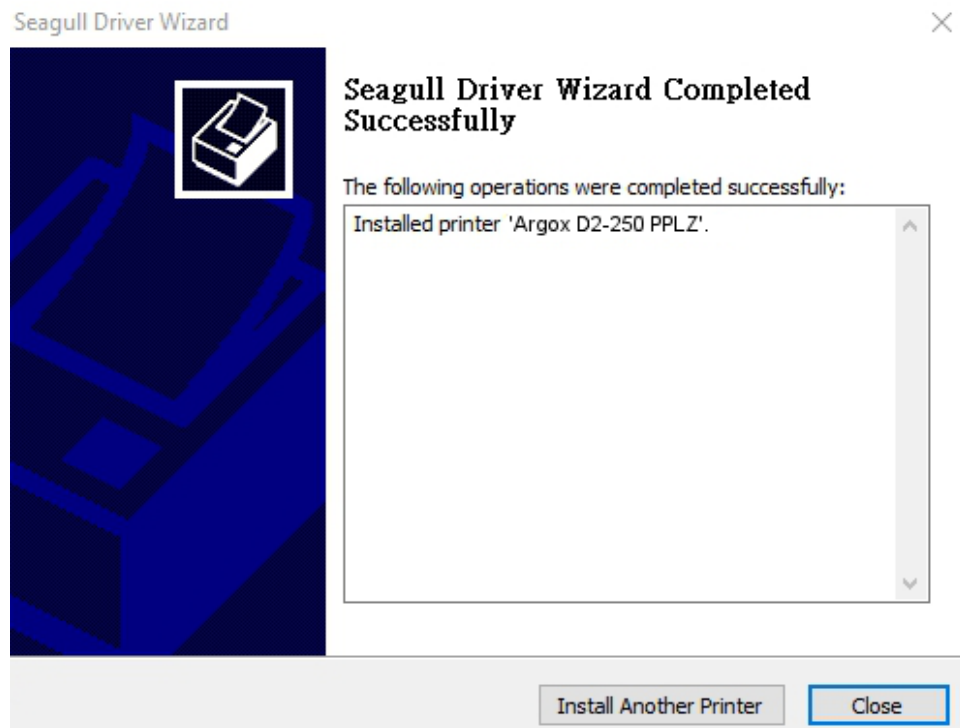

3.5.2 Installing a Printer Driver (for other interfaces except USB)

1. Turn off the printer. Plug the power cable into the power socket on the wall, and then connect the other end of the cable to printer's power socket. Connect the Parallel cable, Serial cable, or Ethernet cable to the proper port on the printer and on your computer.
2. Run the driver from Argox website. On the prompt, Windows Printer Driver, select "I accept..." and click "Next".



- Assign the directory to keep Seagull driver, (for example: C:\Seagull) and click "Next".

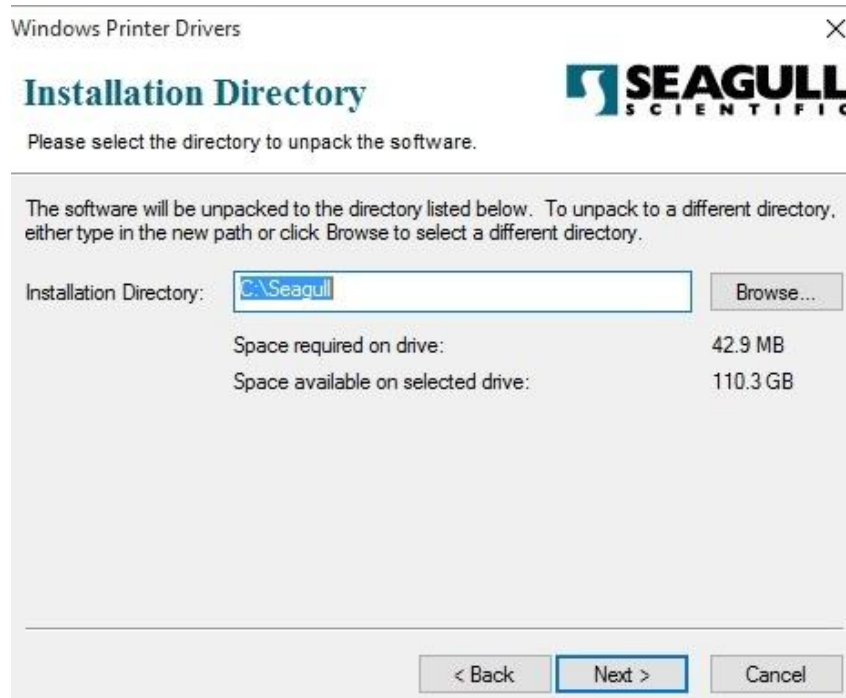

- Click "Finish".



5. Select Install printer drivers and Click "Next"



6. Make sure printer is connected to PC, select "Other" and click "Next":

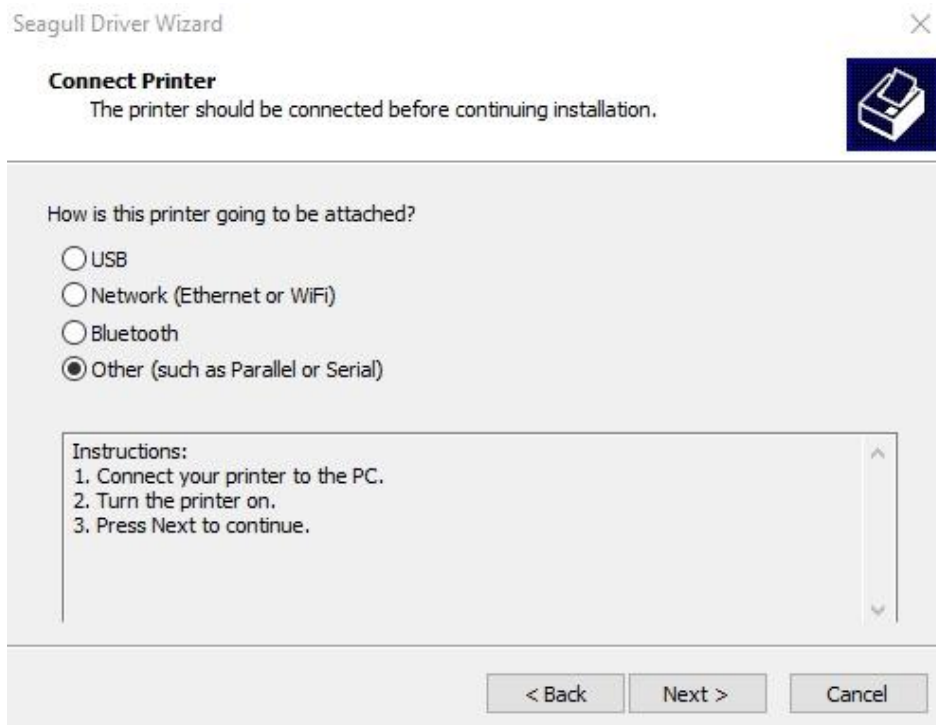

7. Select model & emulation - the following examples are based on model D2-250 PPLZ:

PPLZ:

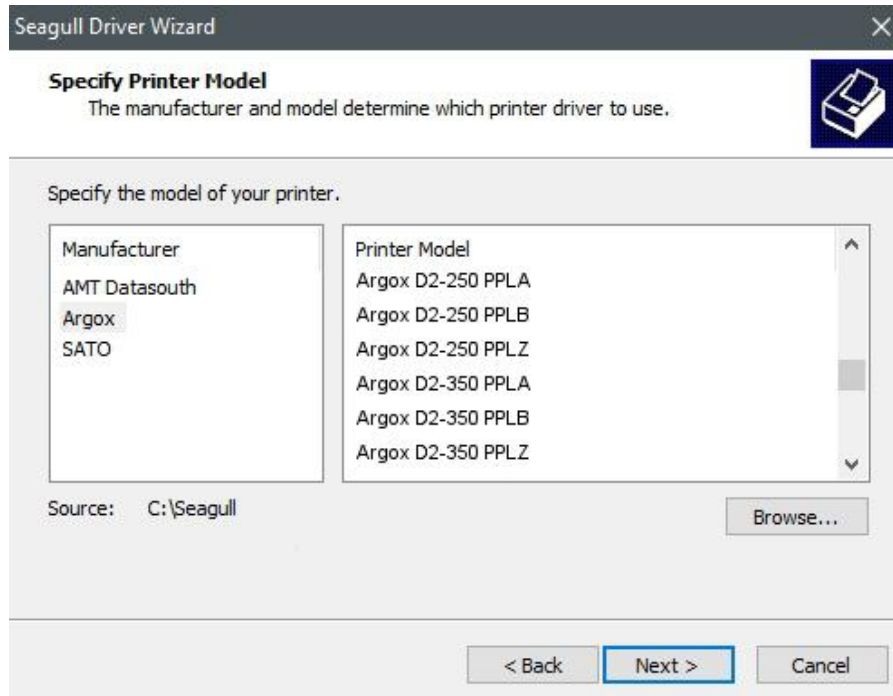

8. Select the port of the printer and click "Next".

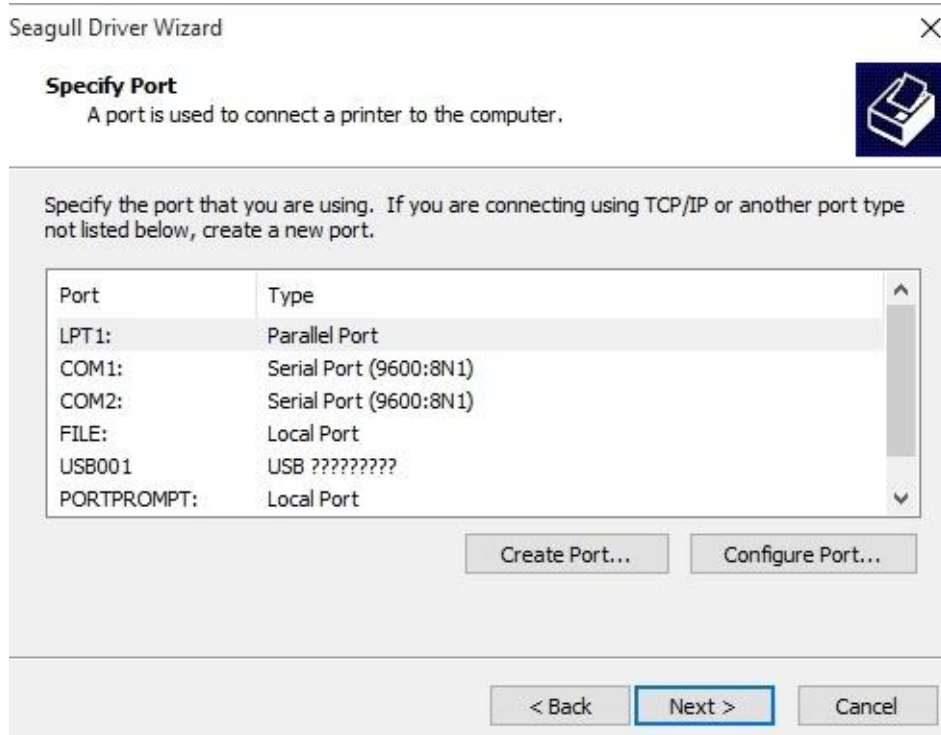

9. Enter Printer name (i.e. Argox D2-250 PPLZ) and select "do not share this printer", and click "Next".

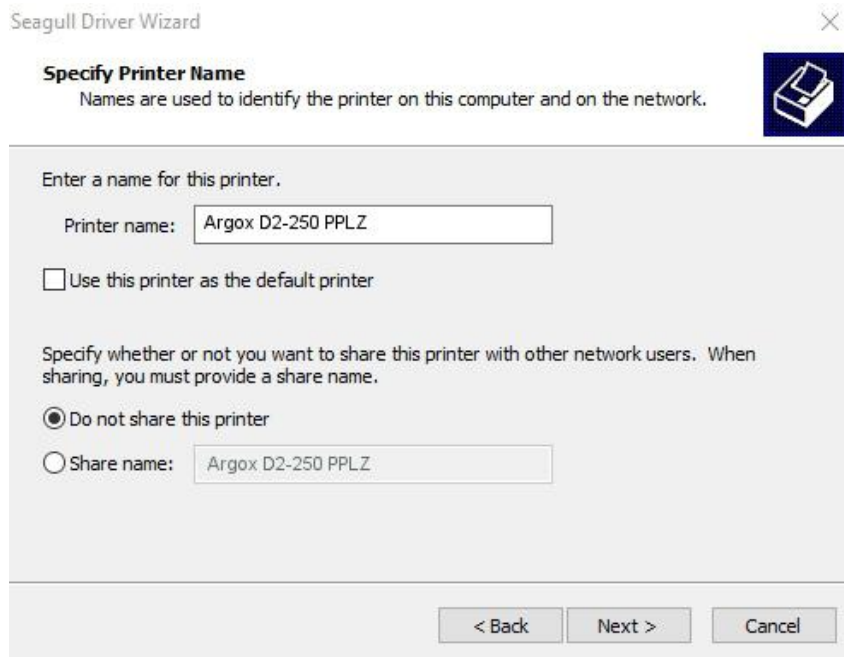

10. Check all the data on the showing screen, if it is correct, click "Finish".

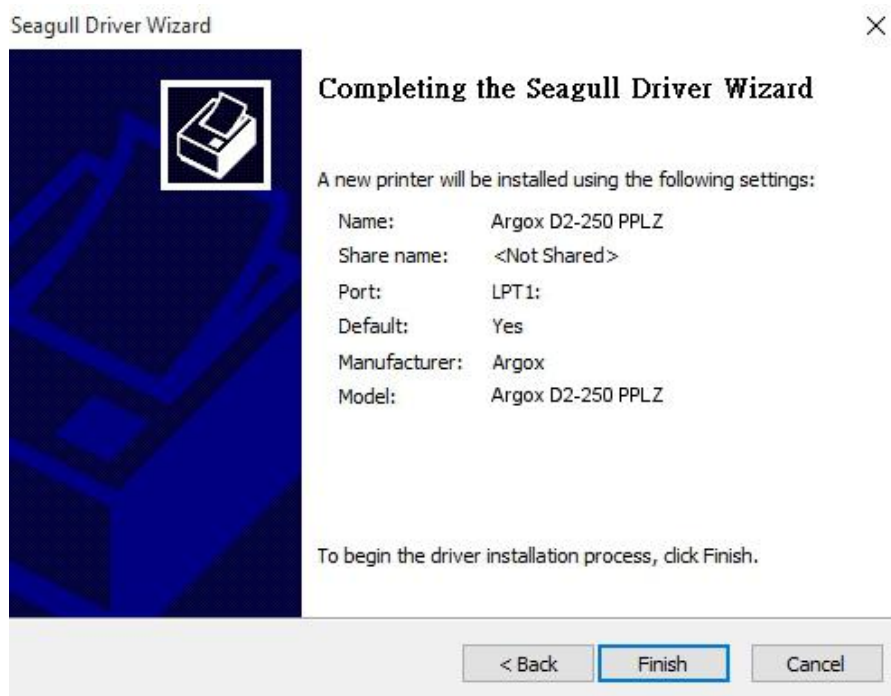

11. After the related files have been copied to your system, click "Finish".

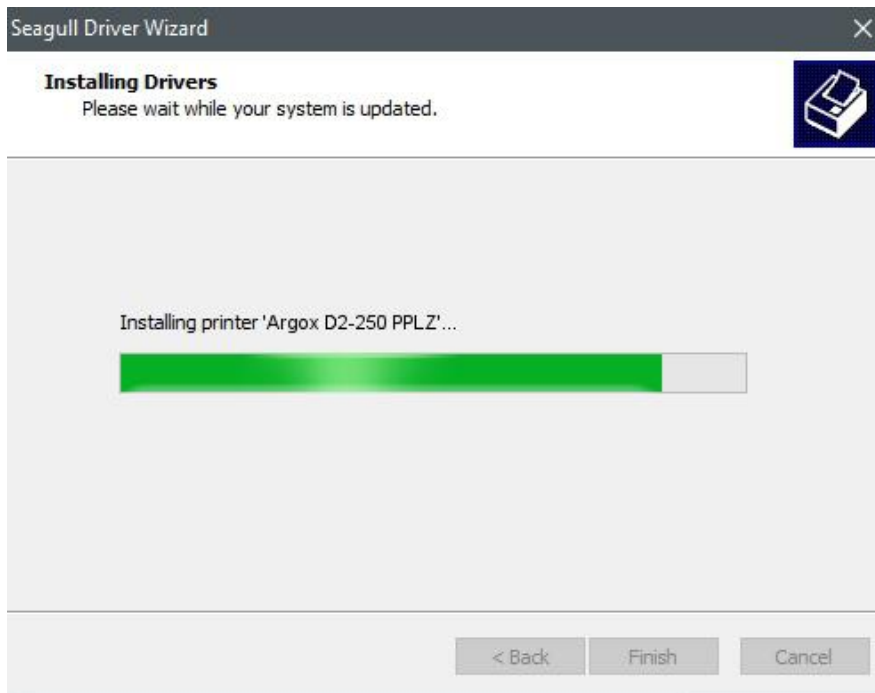

12. After driver installation is complete, click "Close". The driver should now be installed.

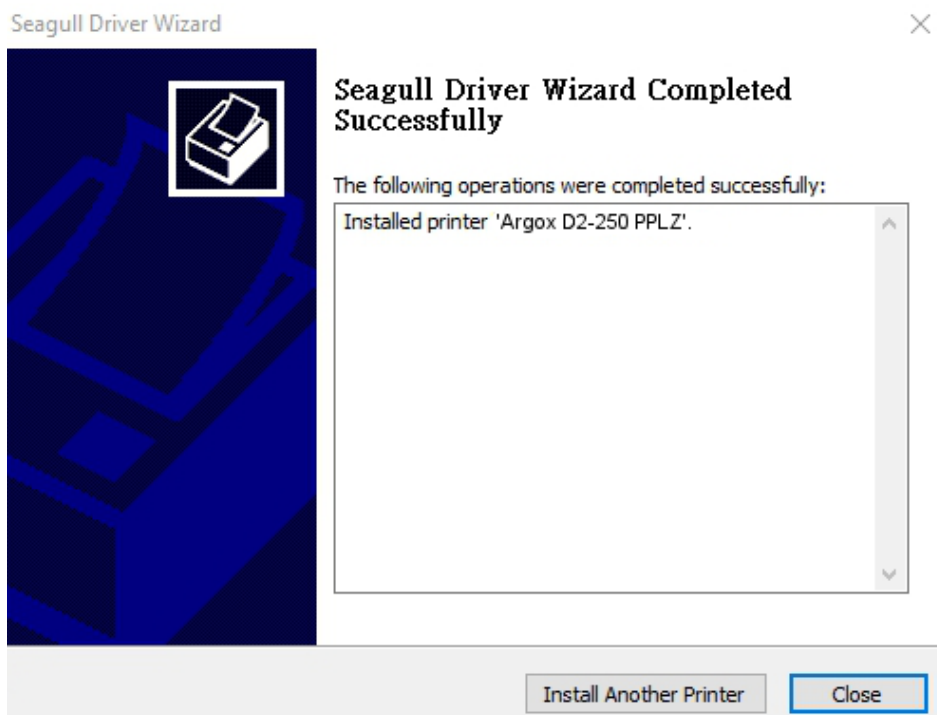

4 Maintenance

This chapter describes routine cleaning procedure.

4.1 Cleaning

To maintain print quality and prolong the printer's life, you need to perform some routine maintenance. Daily maintenance should be done for high volume printing, and weekly for low volume printing.



Caution Always turn off the printer before cleaning.

4.1.1 Printhead

It is essential to keep printhead clean if you want the best print quality. We strongly recommend that you clean the printhead when you load a new media roll. If the printer is operated in critical environment, or the print quality declines, you need to clean the printhead more frequently.

Keep in mind these things before you clean:

- Keep the water away in case of corrosion on heating elements.
- If you just finish printing, wait until the printhead cools down.
- Do not touch the printhead with bare hands or hard objects.

Cleaning steps:

1. Moisten a soft cloth or a cotton swab with ethyl alcohol.
2. Gently wipe the printhead in one direction. That is, wipe it only from left to right or vice versa. Do not wipe back-and-forth, in case dust or dirt attaches to the printhead again.

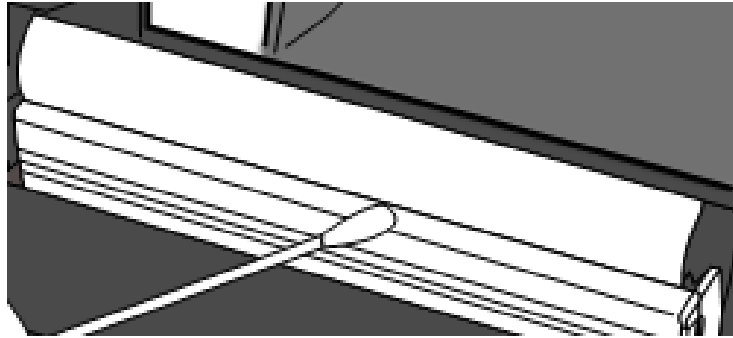

Note Printhead warranty becomes void if printhead serial number is removed, altered, defected, or made illegible, under every circumstance.

4.1.2 Media housing

Use a soft cloth to clean the dust, dirt or debris built up on the **Media Roll Holders, Media Guides** and media path.

1. Moisten a soft cloth with ethyl alcohol.
2. Wipe the **Media Roll Holders** to clean dust.
3. Wipe the **Media Guides** to clean dust and dirt.
4. Wipe the media path to clean paper debris.

4.1.3 Sensor

Media sensors may not be able to detect the media correctly if it becomes dirty.

1. Moisten a soft cloth or a cotton swab with absolute ethyl alcohol.
2. Gently brush sensors to remove the dust away.
3. Use a dry cloth to clean the residue.

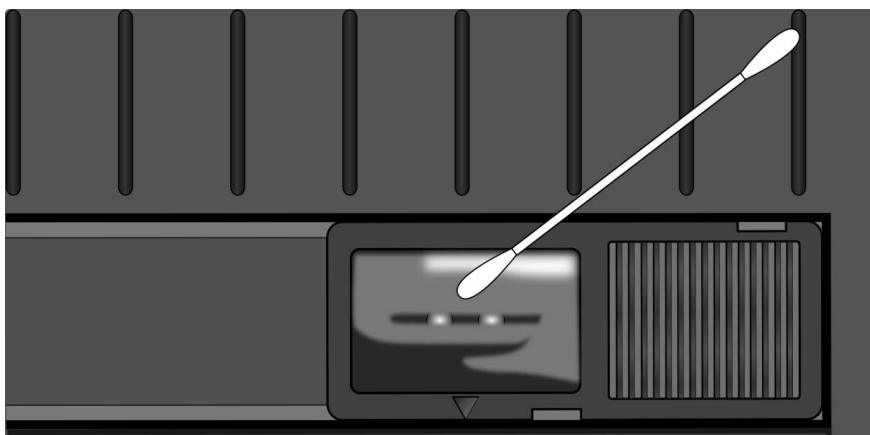

4.1.4 Platen roller

The platen roller is also important for print quality. Dirty platen roller may damage the printhead. Clean the platen roller right away if the adhesive, dirt or dust accumulates on it.

1. Moisten a soft cloth with absolute ethyl alcohol.
2. Gently wipe the platen roller to remove the dust and adhesive.

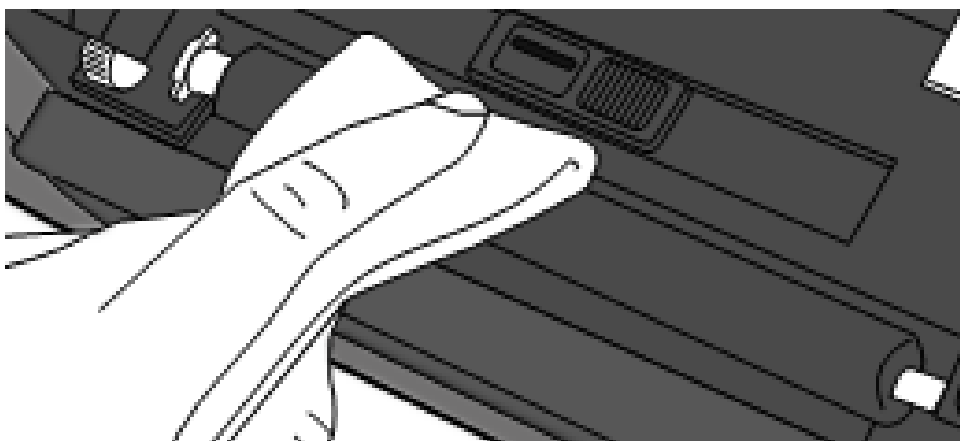

5 Troubleshooting

This chapter provides the information about printer problems and solutions.

5.1 Printer issues

The printer is not turned on

- Did you attach the AC power cord?
- Make sure the power supply's connector is inserted into the printer power jack.
- Check the power connection from the wall socket to the printer. Test the power cord and the socket with other electrical devices.
- Disconnect the printer from the wall socket, and connect it again.

The printer turns itself off

- Turn on the printer again.
- Make sure the power supply's connector and the power cord are plugged properly.
- Make sure the power supply and the power cord are not damaged.
- Use the applicable power supply.
- If the printer keeps turning itself off, check the socket and make sure it has enough power for the printer.

The printer does not feed the media out

- The media is not loaded correctly. See Section 2.3, "Loading Media" to reload the media.
- If there is a paper jam, clear it.

5.2 Media issues

The media is out

- Load a new media roll.

The paper is jammed

- Open the printer and clear the jammed paper.
- Make sure the paper is held properly by the **Media Guides**.

The printing position is not correct

- Did you use the correct media type for printing?
- The media is not loaded correctly. See Section 2.3, “Loading Media” to reload the media.
- The media sensor needs to be calibrated. See Section 3.1, “Media Sensor Calibration” to calibrate the sensor.
- The media sensor is dirty. Clean the media sensor.

Nothing is printed

- The media is not loaded correctly. See Section 2.3, “Loading Media” to reload the media.
- The print data might not be sent successfully. Make sure the interface is set correctly in the printer driver, and send the print data again.

The print quality is poor

- The printhead is dirty. Clean the printhead.
- The platen roller is dirty. Clean the platen roller.
- Adjust the print darkness, or lower the print speed.
- The media is incompatible for Direct Thermal. Use the compatible media instead.
- The media is incompatible for the printer.

5.3 Other issues

There are broken lines in the printed label

- The printhead is dirty. Clean the printhead.

An error occurred when writing data to the USB memory

- Did you insert the USB drive?
- Make sure the USB drive is plugged tightly into the port.
- The USB drive might be broken. Replace it with another one.

The printer is unable to save files due to insufficient USB memory

- Delete the files on your USB drive to free some space, or replace your USB drive with an empty one.

The cutter is experiencing issues

- If there is a paper jam, clear it.
- The cutter has become loose. Fix the cutter in position and tighten it.
- The cutter blade is not sharp anymore. Replace your cutter with a new one.

The printhead temperature is extremely high

- The printhead temperature is controlled by the printer. If it is extremely high, the printer will stop printing automatically, until the printhead is cool down. After that, the printer will resume printing automatically, if there is any unfinished print job.

The printhead is broken

- Contact your local dealer for assistance.

6 Specifications

This chapter provides specifications for the printer. Specifications are subject to change without notice.

6.1 Printer

Model	D2-250	D2-350
Print method	Direct Thermal	
Resolution	203 dpi (8 dots/mm)	300 dpi (12 dots/mm)
Media Alignment	Centered	
Operation Mode	Standard: Continuous mode , Tear-off mode Optional: Cutter mode , Peeler mode	
Sensor	Reflective Sensor (Movable) Media Transmissive sensor x 1 (fixed, 6.27mm offset) Head Open Switch	
Operation interface	LED indicator x 2, Button x 1	
Print Speed	2, 3, 4, 5, 6, 7 inches/sec (50.8, 76.2, 101.6, 127, 152.4, 177.8 mm/sec)	2, 3, 4, 5 inches/sec (50.8, 76.2, 101.6, 127 mm/sec)
Printable Area	2 & 3ips for peel off mode Max. length 100"	2 & 3ips for peel off mode Max. length 50"
Print Ratio	Average print ratio within 15 % or less (whole print layout area) Full width with 1mm pitch is required	
Interface	USB hosts(Type A), USB device(Type B) Optional: RS-232, Ethernet ,Wi-Fi(IEEE 802.11b/g/n), Bluetooth V4.2	
Programming Language	PPLA+PPLB+PPLZ	
Accessories	Peeler, Full Cutter, External Media Stand	
On-Board Memory	Standard Memory (Flash ROM): 16 MB User Memory: 8 MB Standard Memory (SDRAM): 32 MB	

6 Specifications

	USB storage up to 32 GB (FAT32 format only)
CPU Type	32 bit RISC microprocessor
Software---Label editing	Windows Driver (Windows Vista/ Win 7/ Win 8/ Win 10), BarTender® from Seagull Scientific
Software--- Utility	Printer Tool
Agency Listing	CB, CE, FCC, TUV/cTUVus, Energy Star

6.2 Media

Properties	Description
Media Size	Max. width: 60mm Min. width: 12mm Thickness: 0.00236"~0.00787" (0.06mm~0.2mm) 5"(127mm) OD on a 1"/1.5" (25.4/38 mm) ID core 4.5"(115mm) OD on a 0.5" (12.7mm) ID core Dealer Option external media stand 8" OD on 1"/3" ID Core Min. width for partial cutter options. Min. length for cutter options.
Media Type	Direct Thermal Label Direct Thermal Tag Roll Paper (Inside Wound or Outside Wound) Fanfold Paper

6.3 Electrical and operating environment

Properties	Range
Power Supply	Voltage: AC 100 V ~ 240 V \pm 10 % (full range) Frequency: 50 Hz - 60 Hz \pm 5 %
Temperature	Operating: 41°F~104°F(5 °C ~ 40 °C) Storage: -4°F~140°F(-20 °C ~ 60 °C)
Humidity	Operating: 25 %RH ~ 85 %RH (non-condensing) Storage: 10 %RH ~ 90 %RH (non-condensing)

6.4 Physical dimension

Dimension	Size and Weight
Size	W 116 mm x H 170 mm x D 215 mm
Weight	1.05 kg (excluding media and accessories)

6.5 Fonts, Barcodes, and Graphics Specification

The specifications of fonts, bar codes and graphics depends on the printer emulation.

The emulations PPLA, PPLB, and PPLZ are printer programming languages, through which the host can communicate with your printer.

Printer Programming Language PPLA

Programming Language	PPLA
Internal fonts	9 fonts with different point size 6 fonts with ASD smooth font. Courier font with different symbol sets.
Symbol sets (Code pages)	Courier font symbol set: Roman-8, ECMA-94, PC, PC-A, PC-B, Legal, and PC437 (Greek), Russian.
Soft fonts	Downloadable soft fonts by Print Tool
Font size	1x1 to 24x24 times
Character rotation	0, 90, 180, 270 degree, 4 direction rotation
Graphics	PCX, BMP, IMG, GDI and HEX format files
1D Barcodes	Code 39、UPC-A、UPC-E、Code 128 subset A/B/C、EAN-13、EAN-8、HBIC、Codabar、Plessey、UPC2、UPC5、Code 93、Postnet、UCC/EAN-128、, UCC/EAN-128 K-MART、UCC/EAN-128 Random weight、Telepen、FIM、Interleaved 2 of 5 (Standard/with modulo 10 checksum/ with human readable check digit/ with modulo 10 checksum & shipping bearer bars) 、GS1 Data bar (RSS)
2D Barcodes	MaxiCode、PDF417、Data Matrix (ECC 200 only) 、QR code、Composite Codes、Aztec

Printer Programming Language PPLB

Programming Language	PPLB
Internal fonts	5 fonts with different point size
Symbol sets (Code pages)	8 bits code page : 437, 850, 852, 860, 863, 865, 857, 861, 862, 855, 866, 737, 851, 869, 1252, 1250, 1251, 1253, 1254, 1255 7 bits code page: USA, BRITISH, GERMAN, FRENCH, DANISH, ITALIAN, SPANISH, SWEDISH and SWISS
Soft fonts	Downloadable soft fonts by Print Tool
Font size	1x1 to 24x24 times
Character rotation	0, 90, 180, 270 degree, 4 direction rotation
Graphics	PCX , Binary Raster, BMP and GDI
1D Barcodes	Code 39、UPC-A、UPC-E、Matrix 2 of 5、UPC-Interleaved 2 of 5、 Code 39 with check sum digit 、Code 93、EAN-13、EAN-8 (Standard, 2 /5digit add-on) 、Codabar、Postnet、Code128 subset A/B/C、 Code 128 UCC (shipping container code) 、 Code 128 auto、UCC/EAN code 128 (GS1-128) 、Interleave 2 of 5、Interleaved 2 of 5 with check sum、Interleaved 2 of 5 with human readable check digit、German Postcode、Matrix 2 of 5、UPC Interleaved 2 of 5、EAN-13 2/5 digit add-on、UPCA 2/5 digit add-on、UPCE 2/5 digit add-on、 GS1 Data bar (RSS)
2D Barcodes	MaxiCode、PDF417、Data Matrix (ECC 200 only) 、QR code、 Composite Codes、Aztec

Printer Programming Language PPLZ

Programming Language	PPLZ
Internal fonts	8 (A~H) fonts with different point size. 8 AGFA fonts: 7 (P~V) fonts with fixed different point size (not scalable). 1 (0) font with scaling point size.
Symbol sets (Code pages)	USA1, USA2, UK, HOLLAND, DENMARK/NORWAY, SWEDEN/FINLAND, GERMAN, FRANCE1, FRANCE2, ITALY, SPAIN, MISC, JAPAN, IBM850, Multibyte Asian Encodings, UTF-8, UTF-16 Big-Endian, UTF-16 Little-Endian, Code page 1250, 1251, ,1252, 1253, 1254
Soft fonts	Downloadable soft fonts by Print Tool
Font size	1x1 to 10x10
Character rotation	0, 90, 180, 270 degree, 4 direction rotation
Graphics	GRF, Hex and GDI
1D Barcodes	Code39、UPC-A、UPC-E、Postnet、Code128 subset A/B/C、 Interleave 2 of 5、 Interleaved 2 of 5 with check sum、 Interleaved 2 of 5 with human readable check digit、Code 93、Code 39 with check sum digit、 MSI、EAN-8、Codabar、Code 11、EAN-13、Plessey、GS1 Data bar (RSS) 、Industrial 2 of 5、Standard 2 of 5、Logmars
2D Barcodes	MaxiCode、PDF417、Data Matrix (ECC 200 only) 、QR code、 Composite Codes、Aztec

6.6 Ethernet(Optional)

Properties	Description
Port	RJ-45
Speed	10Base-T/100Base-T (Auto Detecting)
Protocol	ARP, IP, ICMP, UDP, TCP, HTTP, DHCP, Socket, LPR, IPv4, IPV6, SNMPv2
Mode	TCP Server/Client, UDP Client
Technology	HP Auto-MDIX, Auto-Negotiation

6.7 Bluetooth(Optional)

Properties	Bluetooth I/F
Standard	Bluetooth 4.2
Enable Device	BT PRINTER
Operating Temperature	41°F (5°C) ~ 104°F (40°C)
Storage Temperature	-4°F (-20°C) ~ 140°F (60°C)
Operating Humidity	25 ~ 85 % Non-condensing R.H
Storage Humidity	10 ~ 90 % Non-condensing R.H
Connection Form	Only one-to-one connection is supported.
Support Profile	Serial Port Profile (SPP) PIN code is supported.
Class of Radio Transmission	CLASS 2
Transmission Method	Bi-directional (Half-duplex)
Flow Control	Credit based flow control
Operating Mode	Slave Mode
Transmission Distance	10 m (360 degrees)
SR Mode in Page/Inquiry Scanning	R1 Scan Interval 1.28 sec. Scan Window 22.5 msec.
RF Frequency Range	2402 ~ 2480 MHz
Nominal Output Power	+4 dBm (2.51 mW) MAX

6.8 Wireless LAN (Option)

Properties		Wireless LAN I/F				
Hardware	Protocol	IEEE 802.11 b/g/n				
	Enabled Device	WIRELESS PRINTER				
	Operating Temperature	-20°C ~ +85°C				
	Destination	USA	Europe			
	Frequency (Center Channel)	2412 ~ 2462 MHz	2412 ~ 2472 MHz			
	Channel	1 ~ 11 ch	1 ~ 13 ch			
	Spacing	5 MHz				
	Transmission Speed/Modulation	IEEE 802.11b	Transmission Method	Conforming to IEEE 802.11b DSSS method		
			Channel	Depending on the country		
			Data Transmission Speed/Modulation	11/5.5 Mbps: CCK 2 Mbps: DQPSK 1 Mbps: DBPSK		
			IEEE 802.11g	Transmission Method	Conforming to IEEE 802.11g OFDM method DSSS method	
				Channel	Depending on the country	
				Data Transmission Speed/Modulation	54/48 Mbps: 64 QAM 36/24 Mbps: 16 QAM 18/12 Mbps: QPSK 9/6 Mbps: BPSK	
IEEE 802.11n		Transmission Method	Conforming to IEEE802.11n OFDM method			
		Channel	(US)1-11ch (JP/DE)1-13ch			
		Data Transmission Speed/Modulation	20MHz : 6.5M / 7.2M / 13M / 14.4M / 19.5M / 21.7M / 26M /28.9M / 39M / 43.3M / 52M / 57.8M / 58.5M / 65M /			

Properties		Wireless LAN I/F		
		72.2M(Auto-sensing)		
Antenna	External antenna			
Aerial power	802.11b	Max +15 dBm		
	802.11g	Max +17 dBm		
	802.11n	Max +17 dBm		
Software	Connection mode	Infrastructure, Adhoc		
	Default IP Address	192.168.1.1		
	Default Subnet Mask	255.255.0.0		
	Default ESSID	WIRELESS PRINTER		
	Security	IEEE 802.11i		
		Cryptography	WEP 128 bit, TKIP (WPA), AES (WPA2)	
		Authorization	Open Key (for WEP), PSK	
	Protocol (*)	TCP/IP, Socket, DHCP		
	Wireless LAN Parameter Setting and Status Monitor	Parameter Setting: Command (PC Setting Tool)		

6.9 Ports

This section provides information about IO port specifications for the printer.

6.9.1 USB

There are two common USB connectors. Typically, type A is found on hosts and hubs; type B is found on devices and hubs. The figure below shows their pinouts.

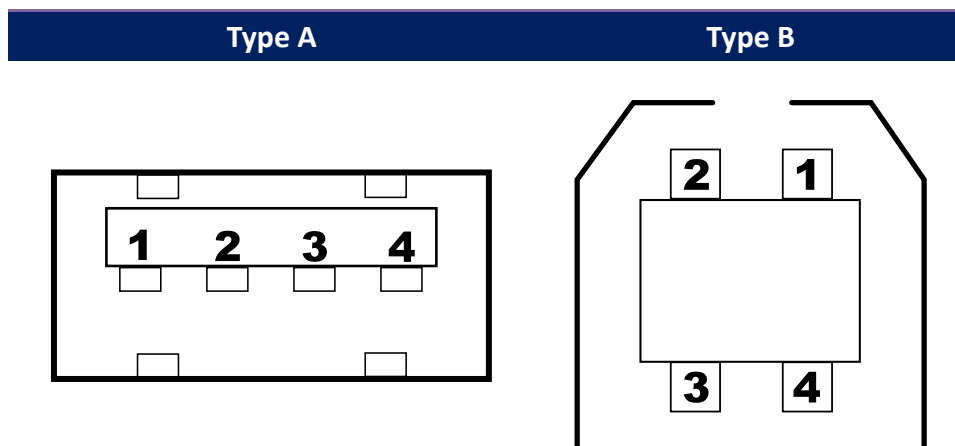

Pin	Signal	Description
1	VBUS	+5V
2	D-	Differential data signaling pair -
3	D+	Differential data signaling pair +
4	Ground	Ground

6.9.2 Ethernet(Option)

The Ethernet uses RJ-45 cable, which is 8P8C (8-Position 8-Contact). The figure below shows its pinout.

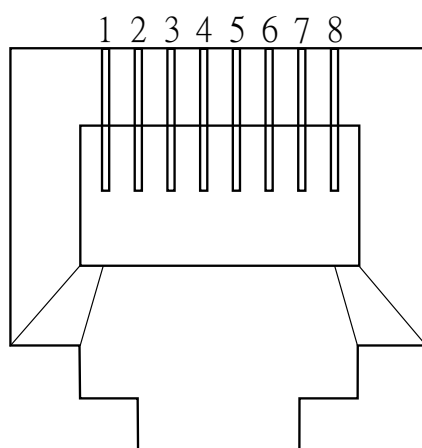

Pin	Signal
1	Transmit+
2	Transmit-
3	Receive+
4	Reserved
5	Reserved
6	Receive-
7	Reserved
8	Reserved

6.9.3 RS-232C(Optional)

The RS-232C on the printer is DB9 female. It transmits data bit by bit in asynchronous start-stop mode. The figure below shows its pinout.

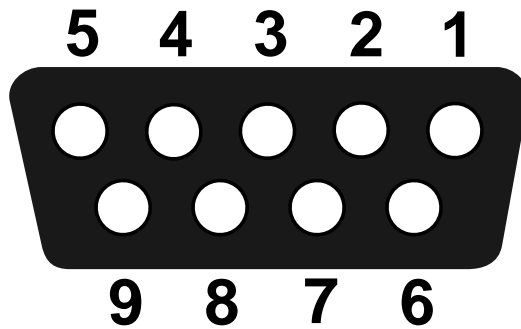

Pin	Signal	Description
1	NA	No Function
2	TxD	Transmit
3	RxD	Receive
4	NA	No Function
5	GND	Ground
6	NA	No Function
7	CTS	Clear to Send
8	RTS	Request to Send
9	NC	No Connection

Host (DB9)			Printer (DB9)		
Signal	Description	Pin	Pin	Description	Signal
CD	Carrier Detect	1	1	No Function	NC
RxD	Receive	2	2	Transmit	RxD
TxD	Transmit	3	3	Receive	TxD
DTR	Data Terminal Ready	4	4	No Function	NC
GND	Ground	5	5	Ground	GND
DSR	Data Set Ready	6	6	No Function	NC
RTS	Request to Send	7	7	Clear to Send	RTS
CTS	Clear to Send	8	8	Request to Send	CTS
CI		9	9	No Function	NC